

ZEISS Lightsheet Z.1

Sample Preparation



We make it visible.

ZEISS Lightsheet Z.1

Sample Preparation

Author: Flood P.M., Kelly R., Gutiérrez-Heredia L.
and E.G. Reynaud
*School of Biology and Environmental Science,
University College Dublin, Ireland*

Date: Sept 2013

This paper describes theoretical and practical aspects of sample preparation for Light Sheet Fluorescence Microscopy (LSFM). We present general rules for sample handling and mounting, as well as guidelines with respect to the best preparative technique to use, taking into account sample type, structure and properties. Step by step protocols and recommended materials for ZEISS Lightsheet Z.1 samples are included. These protocols cover sample preparation ranging from micrometer-sized fluorescent beads to millimeter-sized insects, providing detailed information relating to preparation and observation techniques. Finally, this paper identifies the main artifacts and problems that can result from the preparation techniques.

CONTENTS (click text to go to page):

1	INTRODUCTION	3	3	SPECIFIC EXAMPLES OF SAMPLE PREPARATION	22
2	SAMPLE MOUNTING FOR LSFM	5	3.1	Preparation of Fluorescent Beads.....	22
2.1	The perfect Sample for LSFM	5	3.2	Preparation of a Medaka Fish Embryo (<i>Oryza latypes</i>).....	23
2.2	Holding the Sample	6	3.3	Preparation of a Fly Pupa (<i>Drosophila melanogaster</i>).....	24
2.2.1	Embedded Samples.....	8	3.4	Preparation of a Plant Root (<i>Arabidopsis thaliana</i>).....	24
2.2.2	Hanging Samples.....	12	3.5	Imaging Cell Cysts in an Extracellular Matrix Gel.....	25
2.2.3	Enclosed Samples.....	13	3.6	Immunostaining and Preparation of MDCK Cell Cysts.....	26
2.2.4	FEP Tubing	15	3.7	Preparation of a Whole Mount of a Mosquito (<i>Anopheles gambiae</i>).....	27
2.3	Materials and Equipment	15	4	TIPS, TROUBLESHOOTING AND ADDITIONAL INFORMATION	28
2.3.1	Sample Chambers.....	15	4.1	Tips.....	28
2.3.2	Molding and Mounting Supports.....	16	4.2	Troubleshooting.....	28
2.3.3	Sample Holder.....	18	4.3	Suggested Additional Sources of Information.....	30
2.3.4	Gels and Polymers.....	18	4.4	References and Further Reading.....	31
2.3.5	Hydrogel Preparation.....	19	5	Index	33
2.4	Fixation and Fixatives	20			
2.5	Stains and Staining	20			
2.5.1	Choosing a Fluorescent Label.....	20			
2.6	Antifading Agents.....	21			
2.7	Cleaning, Labelling and Storing Samples.....	21			

1. INTRODUCTION

A microscope generally performs best on suitable samples, and when the samples are optimally prepared for the imaging method and microscope type. In Light Sheet Fluorescence Microscopy (LSFM), the sample is commonly mounted in a liquid filled chamber and can be rotated easily. It is scanned through a sheet of light which illuminates the focal plane of a perpendicularly mounted objective lens. The resulting image of an optical section is observed through the objective and is usually detected on a camera-based detector. Since the geometry of the optical beam paths and the optics differ significantly from the conventional inverted and upright compound microscopes, the sample mounting protocols also differ significantly.

If the sample is perfectly transparent, like a block of 1% agarose with beads inside, the light sheet can penetrate deeply and does not change its properties and shape along the illumination axis. Also, the fluorescent signal can reach the detector unperturbed by scattering effects in the specimen or hydrogel. However, if the sample is slightly opaque and diffracts or scatters the light sheet heavily (lipids, lipid vesicles or dense collagen fiber arrays that scatter light strongly) then the well-defined shape and thickness of the sectioning light sheet degrades along the illumination axis. In a second effect, the detected image from a well illuminated sample might still be degraded by such a poorly transparent sample. These effects can contribute independently to the final image quality of a LSFM and can be minimized or worked around by careful sample positioning in the microscope as well as by an optimized sample preparation protocol.

Ultimately, a fully opaque sample that can completely block the penetration of light and a light sheet (insect cuticular structures, bones...) will limit the imaging capabilities of Light Sheet Fluorescence Microscopes and Lightsheet Z.1 to its surface.

Furthermore, the image quality in Fluorescence Microscopy in general – and in LSFM in particular – is not only determined by sample transparency that can be optimized by choosing a suitable model (transparent fish like Medaka), suitable growth conditions (no phenol red in the growth media to avoid autofluorescence) or, potentially, a clearing treatment (not suitable for Lightsheet Z.1). It is also important to have a homogenous signal from a homogeneously labelled sample. Antibodies, for example, are rather large molecules that cannot penetrate deeply into tissue so it is difficult to image a complete juvenile fish after antibody as only the first 50 μm to 100 μm will be labelled, the interior showing reduced signal levels due to the limited diffusion of the antibody.

Samples must be carefully considered when using LSFM such as Lightsheet Z.1 as well as the label or dye used must be carefully chosen. In planning an experiment, it should be kept in mind that most labelling and imaging protocols have been developed for thin specimens and therefore many aspects are not adapted to imaging larger samples such as embryos, tissue slices or complete mosquitoes.

Many organisms have been imaged using Light Sheet Fluorescence Microscopy (Table 1) and you may want to read further specific papers to clarify sample preparation issues.

Topic	Subtopic	Sample/Model Organism	Technique/ LSFM implementation	Reference
Physics	Technical set up of MISERB	Fluorescent beads	MISERB	Fahrback et al, 2010
	Structured illumination	Mouse cochlea	sTSLIM	Schroter et al, 2011
	Light Sheet Characteristics	Fluorescent beads	SPIM	Ritter et al, 2008
	Image formation	Caenorhabditis elegans	DSLIM	Olarte et al, 2012
	Image View fusion	live sea urchin embryo, live Danio rerio embryo	LSFM	Rubio-Guivernau et al, 2012
Biochemistry	Laser Microsurgery	In vitro microtubules	SPIM	Engelbrecht et al, 2007
	Microtubule dynamic instability	In vitro microtubules	SPIM	Keller et al, 2008
	mRNA nuclear export	Chironomus tentans Salivary Glands	SPIM	Siebrasse et al, 2012
	Heterochromatin dynamics	MCDK cells, Drosophila melanogaster	LSFM (FCS)	Capoulade, 2011
	Imaging of engineered gene expression	Drosophila melanogaster	SPIM	Ejsmont et al, 2009
Microbiology	Marine microbiology	Various bacteria, protozoa etc.	LSFM	Fuchs et al, 2002
Cell biology	Adaptive optics to improve imaging performance	Tumour spheroids	waoSPIM	Jorand et al, 2012
	Intracellular imaging	Mammalian cell organelles	Bessel beam plane illumination	Planchon et al, 2011
	Nuclear protein localisation	Cellular spheroids	SPIM	Zanacchi et al, 2011
	Imaging large living samples	MCDK cell cysts	SPIM	Verveer et al, 2007
Plant Biology	Live imaging of root growth	Arabidopsis thaliana	DSLIM	Maizel et al, 2011
	Consecutive imaging of vertically growing root	Arabidopsis thaliana	SPIM	Sena et al, 2011
Developmental Biology	Imaging of developing organs	Danio rerio heart valve	SPIM	Scherz et al, 2008
	Embryogenesis visualisation	Drosophila embryo	SPIM	Huisken et al, 2004
	Zebrafish development	Danio rerio	mSPIM	Kaufmann et al, 2012
	Cell identity lineaging and neurodevelopmental imaging	Caenorhabditis elegans	iSPIM	Wu et al, 2011
	Gene Expression: hour glass model verification	Drosophila melanogaster	SPIM	Kalinka et al, 2010
Physiology	Middle ear structure	Plastic Phantom Structure	(HR) OPFOS	Buytaert et al, 2007
	3D reconstruction of inner ear	Cavia porcellus	OPFOS; LSFM	Hofman et al, 2009
	Brain in vivo imaging	Microspheres	miniSPIM	Engelbrecht et al, 2010
	3D reconstruction for morphological analysis	Bast's valve	OPFOS	Hofman et al, 2007
	Scan of whole brain	Mouse brain	LSFM	Mertz and Kim, 2010
	Neural network imaging	Mouse brain	Ultramicroscope	Dodt et al, 2007
	Sectioning of thick tissues	Mouse cochlea/zebrafish inner ear, brain/ rat brain	TSLIM	Santi et al, 2009
	Imaging neuronal activity	Mouse vomeronasal cells	OCPI	Holekamp et al, 2008
	Imaging of immunolabelled receptors	Mouse	SPIM	Klohs et al, 2008
	Optical sectioning	Meriones unguiculatus cochlea, Hippocampus reidi head, Xenopus laevis	OPFOS	Buytaert et al, 2012
Large organism general biology	Whole organism 3D reconstruction	Ormia ochracea;	LSP	Huber et al, 2001
	Whole organism 3D reconstruction	Emblemasoma auditrix	Ultramicroscope	Jahrling et al, 2010
	Imaging copepod gut contents	Drosophila melanogaster	PLIF	Jaffe et al, 2009
	Whole organism 3D reconstruction	Calanus pacificus	LSFM	Boistel et al. 2011
		Thermocyclops consimilis		

2. SAMPLE MOUNTING FOR LSFM

- Lightsheet Z.1 is optimized for gel embedded samples. The sample chamber must be filled with a watery solution (refractive index of 1.33) at all times, to ensure optimal image quality.
- Lightsheet Z.1 is not designed for the use with clearing reagents. Lightsheet Z.1 is built for aqueous media. Also the sample chamber and the system cavity for the sample chamber and sample holder are not compatible with aggressive chemicals.

2.1 The perfect Sample for LSFM

Prior to observing a sample using a microscope, a preparation step is usually necessary. The sample properties and the microscope characteristics provide guidelines and also limitations to sample preparation and imaging. The classic method of mounting an object for microscopy requires the use of a slide and coverslip that in turn limits access to the sample from one side (Fig. 1/A and B). The sample is not touching the objective lens and the number of refractive barriers is at least two (coverslip, mounting medium) and can increase further if immersion oil is needed.

The depth of the field of view is dependent on the type of objective lens and the sample properties, and will deteriorate with the thickness of the sample. Light Sheet Fluorescence Microscopy (LSFM) utilizes illumination along an axis that is perpendicular to the detection axis (Fig. 1/C). Moreover, it usually allows sample rotation to record multiple image stacks that are acquired independently along different directions. To allow the high level of sample mobility required for such Multiview imaging, the sample is inserted in a sample holder from above. The sample holder is hanging in and linked to an x, y, z, and alpha positioning motor stage, allowing complete three dimensional translations and free rotation around an axis parallel to gravity. This configuration leaves the illumination and the detection paths completely open but requires the preparation of a sample that can be held from above or below in a medium-filled chamber. Such geometry goes hand in hand with the convenient use of water dipping or air objective lenses. As mentioned already in the introduction, another important aspect of sample preparation is the transparency of the specimen, especially when imaging large objects. Ideally, the light sheet penetrates as deeply as possible into the sample. Any obstacle or opaque medium will limit the light sheet penetration depth, generating shadows that will be read out as artifacts on the final image.

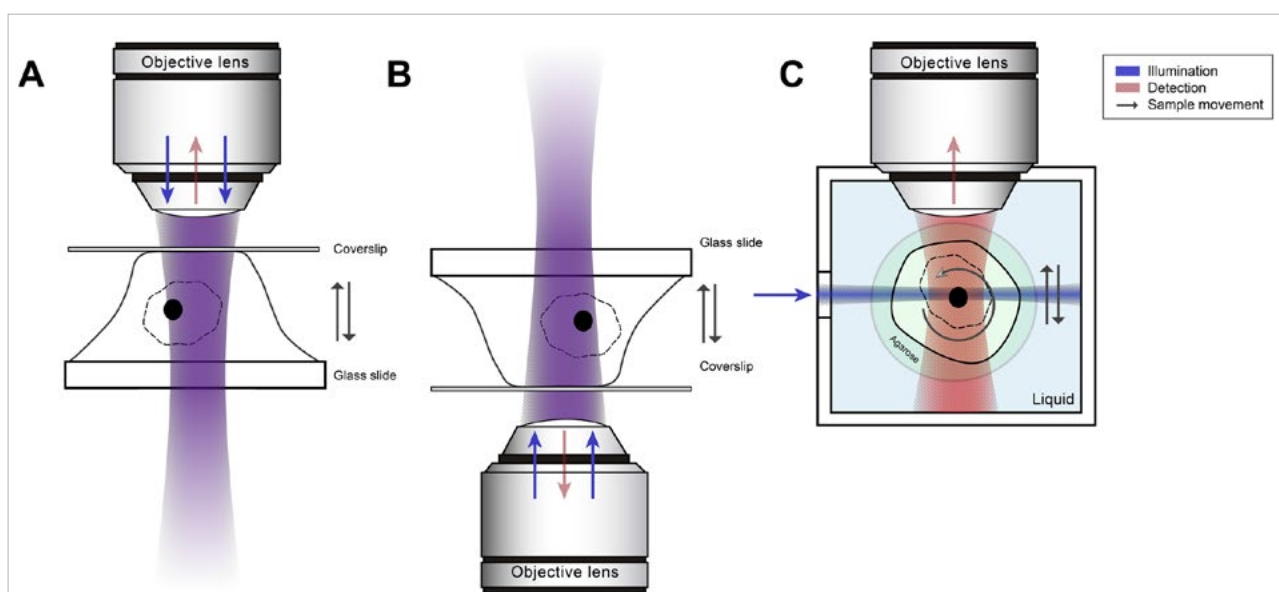

Fig. 1 Relations between the sample and the objective in microscopy. Samples are traditionally isolated from the objective by a glass coverslip (A and B) limiting access to one side only. (C). In LSFM, the illumination is positioned at 90° compared to the detection axis and can be set up in a sideways geometry ("horizontal microscope").

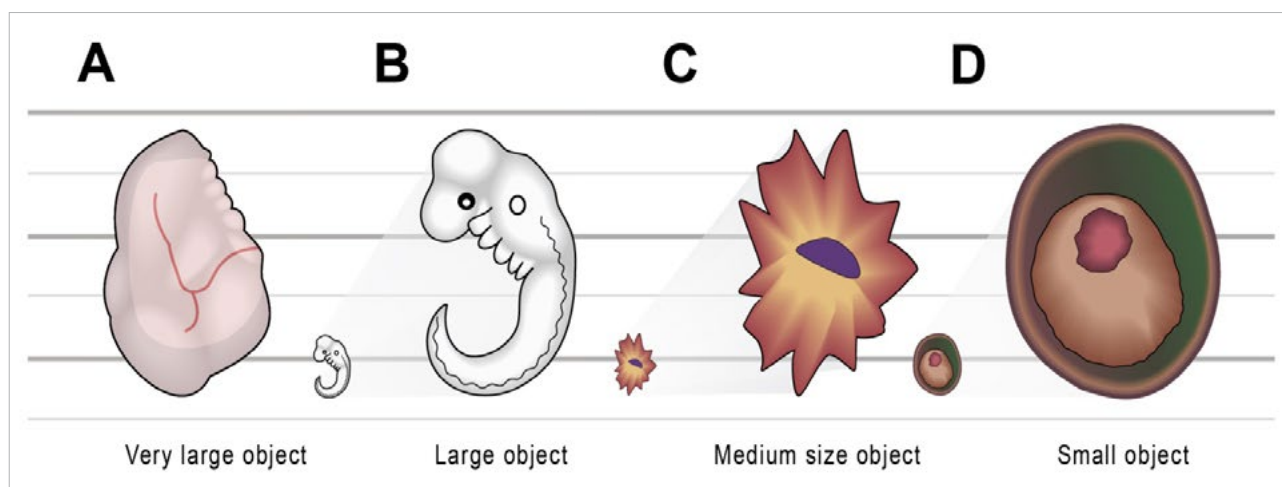

Fig. 2 Different sample types. (A) very large objects (cm), (B) large objects (mm), (C) medium size samples (100 μm) and small samples (10 μm) (D). Each is represented in relation to the following one to allow size comparison.

In LSFM, the sample is usually imaged in a water-based buffer. Generally, it can be kept dry and imaged in air but this has extensive limitations like diffraction due to the significant jump in refractive index from air to the sample material. This has several consequences for sample preparation. First, the refractive index of the mounting medium should be close to that of the sample buffer. The mounting medium should not scatter the illumination or the detection light. Second, the mounting medium should not dissolve in water. Third, its diffusive properties should be close to those of water/medium. Fourth, the medium should be non-toxic for live samples. Fifth, the medium should be flexible to allow the sample to develop. Finally, it should not change its mechanical properties during a period of observation (72 hrs and more).

The following part of this section will deal with sample as a general term but we have devised them in four main classes (Fig. 2) and you can check their size relationship (Fig. 2) and keep that in mind as different samples of different sizes will mean different sample preparation approaches and handling.

2.2 Holding the Sample

In LSFM, the detection axis is at 90° from the illumination axis. There are two main approaches to design such an optical configuration: horizontal or vertical, with respect to the detection axis. In both cases, the sample must be positioned at the intersection between the two axes in order to be observed. Lightsheet Z.1 is a horizontal LSFM implementation and so the sample is presented from above, hanging along the gravitation axis to be scanned through the light sheet in order to acquire stacks of optical section images. Several possibilities exist to hold the sample in such an optical configuration.

In a vertical configuration, the simplest way is to place the sample on a slide or a cuvette filled with medium underneath the objective (Dodt et al., 2007), alternatively the sample can be embedded in a gel rod that can be rotated. In a horizontal configuration, like Lightsheet Z.1, the sample can be either embedded in a stiff gel (Fig. 3/A) (Huisken et al., 2004) hooked and positioned in front of the objective (Fig. 3/B) (Engelbrecht et al., 2007), placed in a container (Fig. 3/C) (Engelbrecht et al., 2007, Kaufmann et al., 2012, Pampaloni et al., 2007) or placed on a slide and positioned at a 45° angle (Fig. 3/D). Alternatively, some investigators are using a system presenting the sample from underneath for better stability (Huber et al., 2001).

- Lightsheet Z.1 is not designed to support mounting on a coverslip (Fig. 3/D).

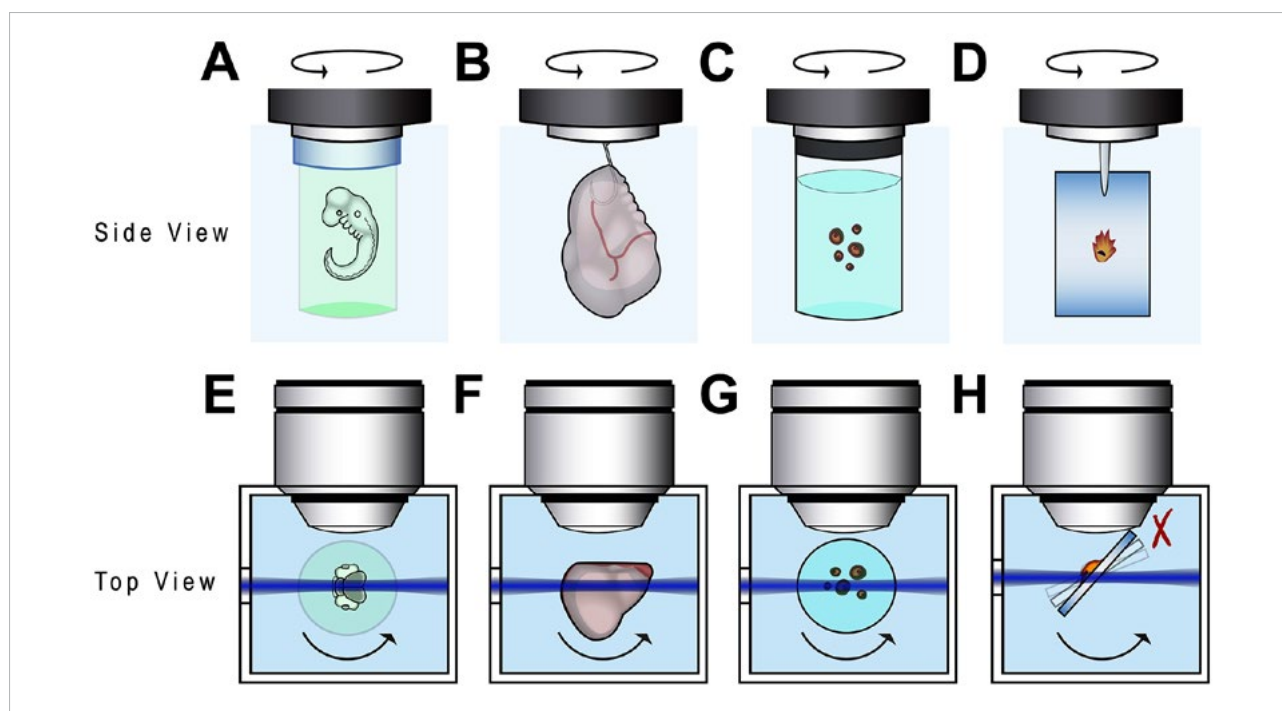

Fig. 3 Sample positioning in LSFM. The sample can be held in front of the objective (A) embedded in gel, (B) by a clip, (C) in a container, or on a coverslip (D; Note: ZEISS Lightsheet Z.1 is not designed to support this way of mounting the sample). (E to H) show an eye bird view of the mounting (A to D).

Every mounting technique has some advantages and disadvantages. Here, we would like to mention one important parameter: the position of the sample relative to the objective lens. Gel embedding (Fig. 3/A and E) is usually safe but the capillary that holds the gel can potentially touch the detection objective. Such collisions are even more likely for hook (Fig. 3/B and F) and coverslip (Fig. 3/D and H) mountings. It is important to remember that in Lightsheet Z.1 the sample can interact with the detection lens as well as the walls of the sample chamber and this could affect the imaging process.

One of the important advantages of the LSFM optics geometry is that it allows so-called Multiview imaging. In this case the sample must be mounted to support the required positioning. One approach used in Lightsheet Z.1 to support this experimental paradigm is to place the object in a gel rod that can be rotated (Fig. 3/A and E) in front of the objective. The hydrogel cylinder must be sufficiently stable to avoid movement during rotation. Typical preparation protocols use 0.8 % to 1.0 % agarose (see below in this section) to take this into account. The following sections will address the four main types of sample preparation that can be used: embedding, hanging, enclosing or flattening.

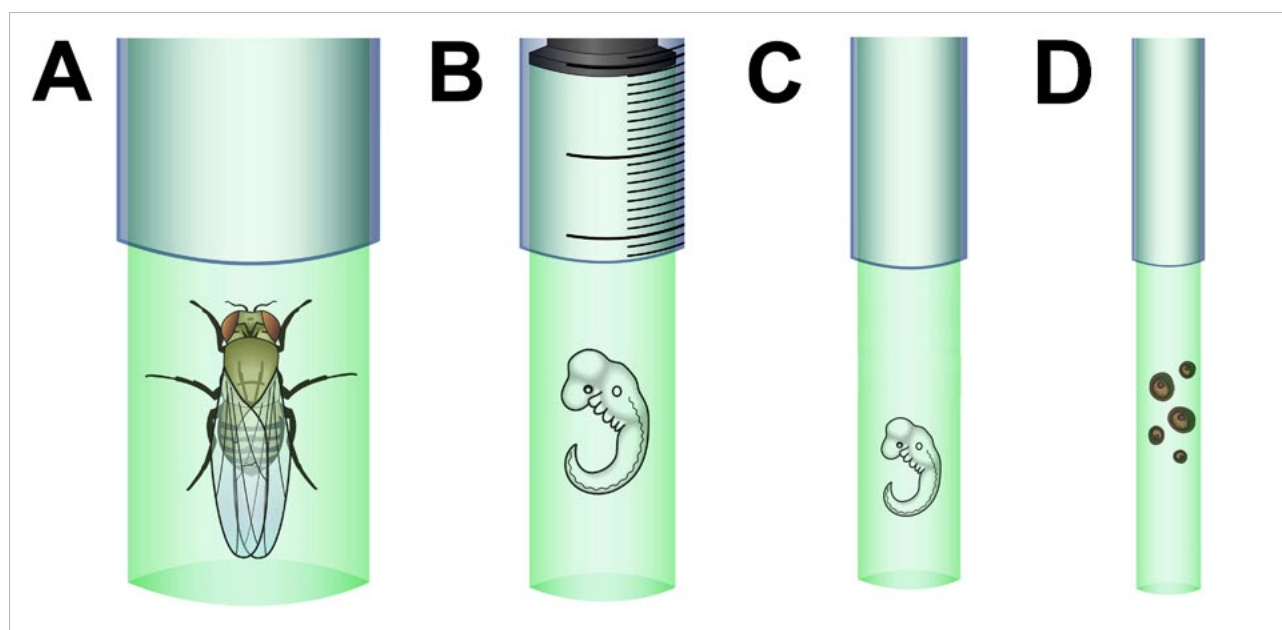

Fig. 4 Embedded samples. Large samples, such as an adult *Drosophila melanogaster*, can be embedded in a large gel tube or a cut 1 ml syringe (A), intermediate size samples, such as a *Medaka* or *Zebrafish* embryo can be prepared by using either a cut 1 ml plastic syringe (see also Fig. 5) or a glass capillary (C and D) and small samples such as *Drosophila melanogaster* embryos or early stage cell clusters can be prepared using a smaller capillary (D).

2.2.1 Embedded Samples

Embedding objects in plastic materials is a routine procedure widely used in the preparation of samples for electron microscopy. In the case of sample preparation for LSFM however, the immobilization of hydrated biological materials must not impair biological activity. It is necessary to keep the object we wish to observe in a perfect condition.

In the case of LSFM, it is also necessary to contain the sample in such a way that it can be positioned and rotated in front of the objective. Furthermore, transparency of the mounting medium is essential to allow imaging. A basic technique of mounting objects for the LSFM is to shape them into a cylinder of gel (for example agarose, see also section 2.3.4 Gels and Polymers) that can then be mounted on a dedicated holder. Lightsheet Z.1 package provides four capillaries sizes adapted to the sample holder to embed objects of various sizes. The special sample holder of Lightsheet Z.1 adapts to hold these capillaries for precise positioning (translation and rotation) of the cylinder-shaped object for observation through the detection optics. The used gel such as agarose behaves like mechanically stabilized water, supporting the object. It can be easily molded and the gel

chosen should have an optical (refraction) index close to that of water. The object can be any size, as the gel can be molded accordingly (Fig. 4/A to D). The various gelling agents and polymers that can be used are discussed in greater detail in section 2.3 Materials and Equipment. The preparation of embedded samples requires a container suitable for molding the gel. The simplest approach is to use any cylinder with a tight-fitting plunger to pump the molten gel into it and let it polymerize inside before pushing it out. The cylinder can be a syringe, a capillary or even a pipette.

In the case of Lightsheet Z.1, the Sample Starter Kit provides four types of color coded capillaries and a specific sample mounting device with color coded sleeves to fit each type of capillary perfectly to the sample holder. Moreover, a syringe sample holder is provided.

Above the preparation of a syringe for large sample and a basic protocol for capillary mounting are discussed.

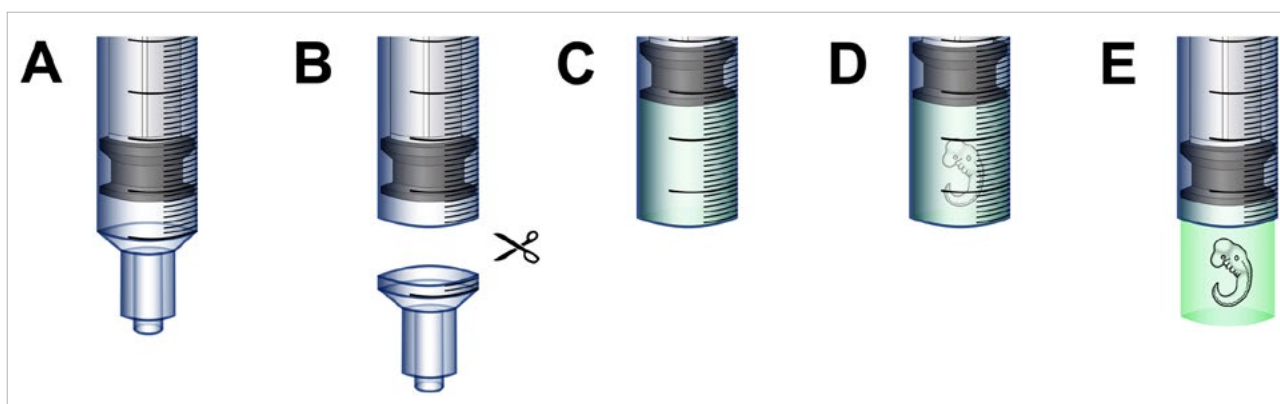

Fig. 5 Preparing a sample embedding container with a syringe. Many tubular objects can be used to make embedded samples. A simple technique is illustrated here. The tip of a syringe is cut away (A, B), agarose can then be easily pumped in using the plunger (C), and the sample can be positioned within the agarose tube (D). After polymerization the sample can be pushed out of the syringe for imaging (E).

An example of how to tailor a syringe for Lightsheet Z.1 sample preparation is illustrated in Fig. 5. The tip of the syringe is cut off to create an even cylinder, and the gel solution is pumped in using the plunger. The sample is then positioned precisely within the gel.

- After the gel has polymerized, the plunger is used to push out the specimen prior to imaging. Imaging is not done through the syringe or capillary, since this would impair the image quality due to the optical properties of the material.

For smaller samples, a capillary can be used as a sample embedding container. There are several commercial companies that provide glass capillaries with specific Teflon plunger. Lightsheet Z.1 sample preparation kit comes with four sizes of capillaries and their specific plunger for this purpose.

- Make sure you use the right capillary for your sample. The sample size should not be more than 2/3 of the final agarose diameter and no less than 1/3. You should also ensure that you use the right plunger for your particular capillary. Finally, the Teflon plunger should be handled carefully and checked regularly for integrity to avoid leaks that will lead to sliding of the gel rod.

The important points to consider are that the materials used do not interfere with the gel, the object to image or the sample preparation (chemical compatibility, melting point, transparency etc.), it must be easily prepared or easily

purchased, it must be compatible to the LSM sample holder as well as the x, y, z stage, it must fit to the sample chamber and should not cause damage to the objective lens once rotated or moved. It is also reasonable to consider reusable sample holders to limit waste. We have found that home-made sample embedding container using 1 ml syringes (BD Biosciences, Braun, Terumo or your local laboratory plastic ware supplier), 1 ml plastic pipettes (see your local laboratory plastic ware supplier such as Falcon or VWR), and glass capillaries (Brand, Sutter Instruments or check your local glassware specialist, see also section 4.3 Suggested Additional Sources of Information) (Fig. 6) are particularly effective. The plungers usually come with the cylinders or can be made using metal rods, plastic or metal wires of an appropriate diameter. Once the sample embedding container is prepared, the sample preparation can begin. The first step consists of preparing the supporting agent at a suitable concentration and temperature. The gelling agent is usually a 0,7 to 1 % solution of low melting agarose in water or PBS, depending of the sample to be embedded (fixed, living, sensitivity to osmotic pressure etc.). If the sample needs to be maintained in a drop of solution or contains water or buffer it is advisable to use a higher concentration of agarose to obtain a final concentration of 1% once the sample is embedded. The use of low melting-point agarose is recommended (Roth, n° 6351.1) as its melting temperature is only approx. 60 °C and it can be maintained liquid at just above 37 °C prior to embedding.

There are two principal methods of embedding an object. The first is to directly mix the object with the agarose then

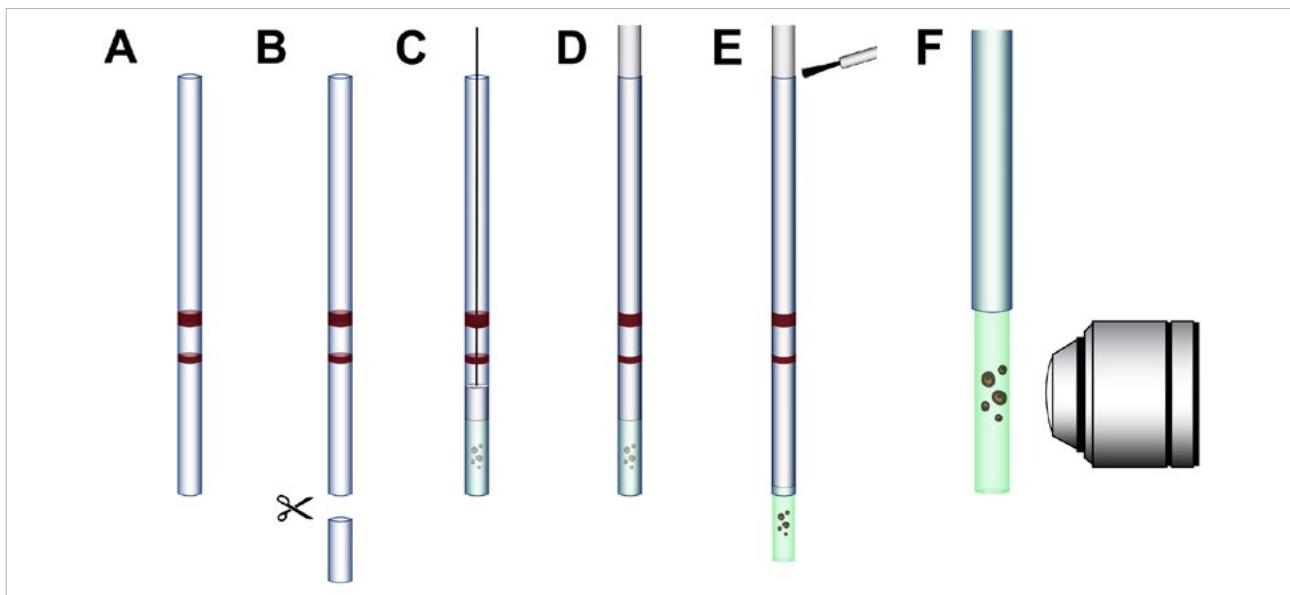

Fig. 6 Preparing a sample embedding container with a capillary. A glass capillary can be used. For ZEISS Lightsheet Z.1 they come from the manufacturer (Brand) in just the right length (A). Other capillaries can be cut to an appropriate length (B), the agarose with the object can be easily pumped in using the suitable plungers with Teflon tips (C). If no such plunger is available it can be made, for example, from a piece of electrical wire (D). To avoid leakage, such a plunger can be sealed with nail polish (E) once the sample is pushed out. The sample can then be imaged (F).

pump it into the sample embedding cylinder. This is a convenient way of embedding very small objects such as pollen grains (Swoger et al., 2007); yeast (Taxis et al., 2006) or cell clusters (Pampaloni et al., 2007) or even large objects like fish embryos. The action of pumping in the sample with the agarose results in a self-alignment of the specimen within the tube (Fig. 7/A, E and F).

The second method is to fill the sample embedding container with the gelling agent, then to place the object within the gel using a needle or forceps (Fig. 7/A, B, C and D). This approach is more suitable for those samples that cannot be easily aligned using the first technique.

In some cases, it may still be challenging to align the specimen in the most suitable way for imaging. The orientation of the sample must then be optimized, so that interesting details are facing the surface of the agarose cylinder with as little material as possible in the optical path. One solution is to fill a syringe with agarose and allow it to cool until it solidifies. The agarose is then pushed out of the syringe (Fig. 8/A and B). A small V-shaped groove can be cut into the gel and the sample then positioned in the V-groove.

The gel can be cut into various shapes depending on the needs (cylinder, hole). Afterwards the gel with the specimen is pulled back into the syringe and is covered with more molten agarose. The agarose is allowed to cool and solidify, this time period can be shortened by cooling the whole sample. For example the housing of the sample can be rinsed with cold water, although care must be taken to ensure that the polymer does not come into contact with the water, otherwise the cooling agarose would become diluted and lose its stability necessary for holding the sample. After polymerization, the sample is ready for imaging.

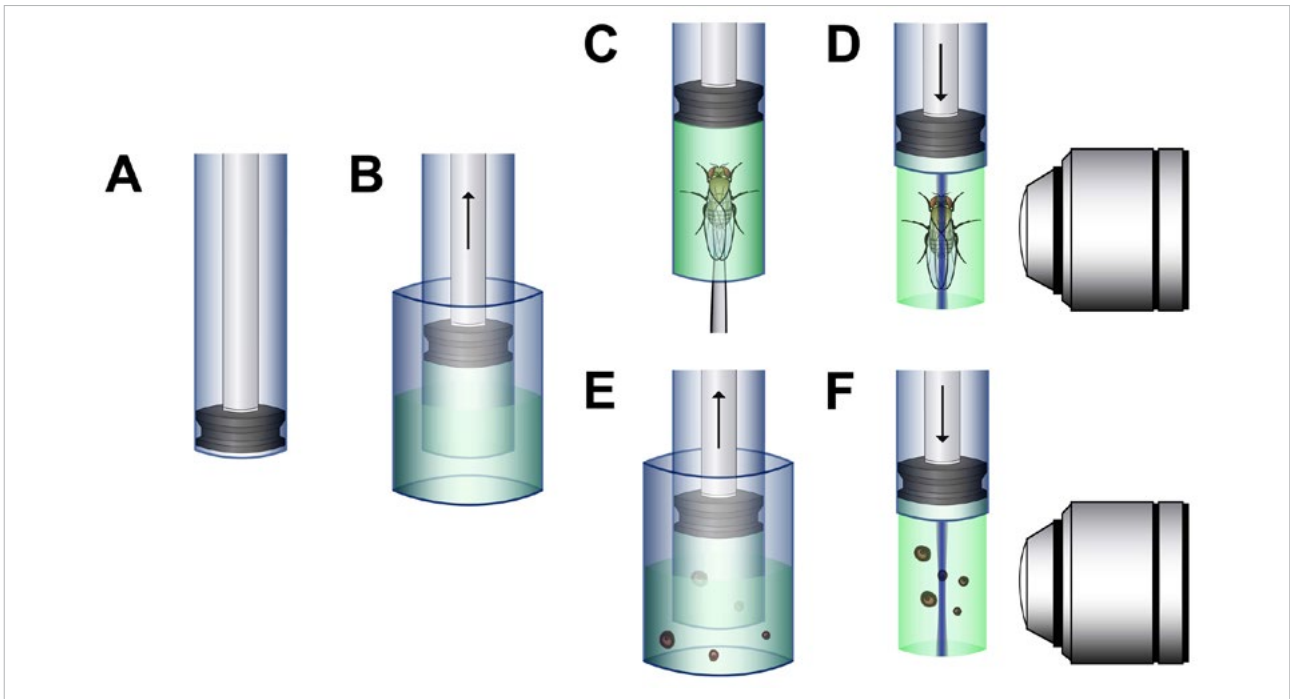

Fig. 7 Basic principles of sample embedding. A cylinder with a suitable plunger is used as a mounting device (A). The 1 % low melting-point agarose is melted, then brought to 37 °C, then pumped into the cylinder. (B) The object is then introduced to the agarose with a needle or forceps. (C) Once solidified, the embedded sample can be pushed out and imaged (D). Alternatively, the object, devoid of water, or other solution, is added to a solution of 1 % low melting-point agarose at just above gelling temperature (typically 40 °C) and sucked into the cylinder (E) and then allowed to polymerize. The embedded sample can then be pushed out and imaged (F).

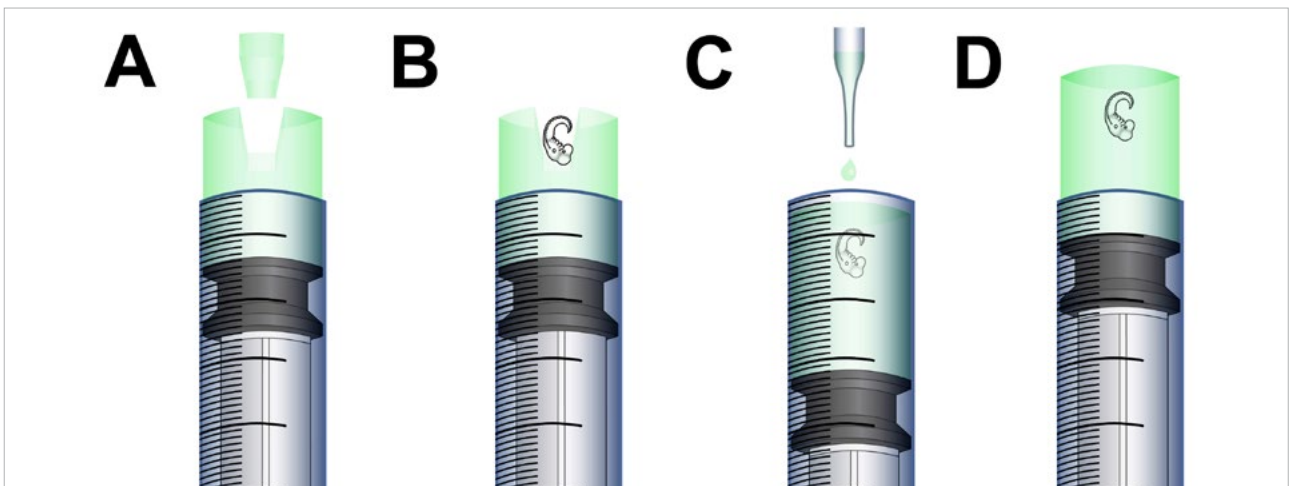

Fig. 8 Aligning an embedded sample. The sample can be aligned in a particular orientation to allow the details of interest to be close to the outer surface of the agarose. The solidified agarose is pushed out the syringe a few millimeters and a small v-groove is cut into the cylinder to take up the sample (A). The sample is placed into the v-groove (B). The sample on the agarose is pulled back into the syringe and more agarose is added (C). After the cylinder has completely solidified the sample is pushed out of the syringe allowing free sight on to the sample (D). The same approach can be used to carve a central tunnel in the middle of the agarose to align the sample along the agarose tube axis.

2.2.2 Hanging Samples

- Lightsheet Z.1 is optimized for gel embedding samples. The sample chamber must be filled with a watery solution (refractive index of 1.33) at all times, to ensure optimal image quality.
- This mounting technique can also be used, but will require some initial adaptations to the sample holder.

An intuitive way of imaging an object is to simply take it as it is and place it in front of an objective. In an LSM, this can be done by hanging the object in front of the objective where the axis of rotation and gravity are parallel. This can be achieved using a simple hook made of glass, stainless steel or plastic (Fig. 9/A). This mounting technique can be used for large samples such as organs (for example the brain) or complete organisms (insect, fish). One main drawback is the fact that the hook will partially damage the object and may also interfere with the field of view.

- Lightsheet Z.1 has a maximum Field of View of approx. 2.5 mm (depending on zoom settings). This and the dimensions of the sample chamber might limit the size of the sample.

Interestingly, such a hook can also be tailored to mount small objects embedded in agarose. The drop of agarose is more stable as it is closely held by the hook. This is very important when imaging at very high magnification (100x). The hanging method has been successfully used for imaging single *Saccharomyces cerevisiae* (Taxis et al., 2006) and holding fish fins during laser nanosurgery (Engelbrecht et al., 2007).

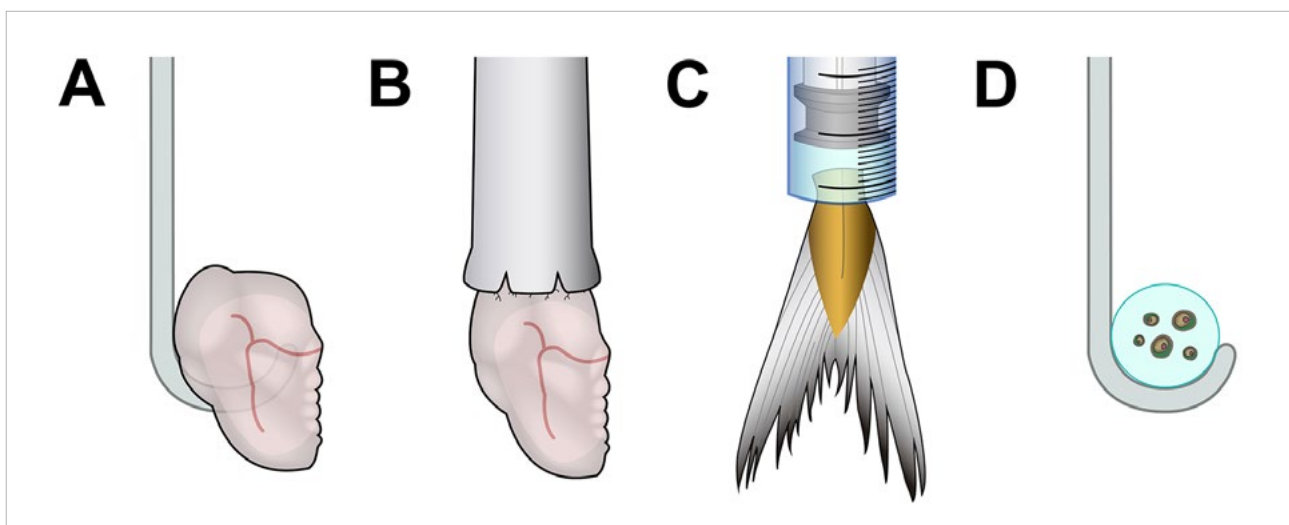

Fig. 9 Different ways of hanging a sample. Samples can be either hooked or deposited on a bent glass capillary (A, D), glued to a rod or capillary (B), or clamped on a syringe tip using the plunger and the syringe body as a holder (C).

2.2.3 Enclosed Samples

- Lightsheet Z.1 is optimized for gel embedding samples. The sample chamber must be filled with a watery solution (refractive index of 1.33) at all times, to ensure optimal image quality.
- This mounting technique can also be used, but will require some initial adaptations to the sample holder.

The last important technique of holding samples to be mentioned in this section is to create a container that can hold the object in front of the objective lens. This technique is particularly suitable for specimens that should not be embedded (for example due to temperature, physical constraints etc.) or that need to be constantly maintained in a specific buffer (for example in vitro assays, or living cells). The container must be suitable for LSFM imaging. It must be basically transparent and be suitable for the object but also for the imaging chamber and the sample

holder. It can be hooked or clipped using specific holders. There are two main methods of generating such containers, using gelling agent to shape out a container (Fig. 10/A) or using polymers such as PTFE (Polytetrafluorethylen, Teflon) or FPE (Fluorinated Ethylene Propylene) to make it (Fig. 10/B and C).

The container can be easily molded using a gelling agent specifically chosen for its stiffness and transparency. The custom-made molding system is made from a syringe where the plunger has been modified to hold a cylinder of smaller diameter. This system allows tailoring of the size of the container wall and is easy to use for molding (Fig. 11/A). The plunger is pulled into the syringe body and filled with molten gelling agent. The plunger is further pulled to create the bottom part of the container (Fig. 11/B and C). Alternatively, the system can be used to generate a hollow tube that can be subsequently sealed (Fig. 11/D). The gelling agent is left to polymerize and then the tube is removed from the modified plunger. The containers can be used directly or

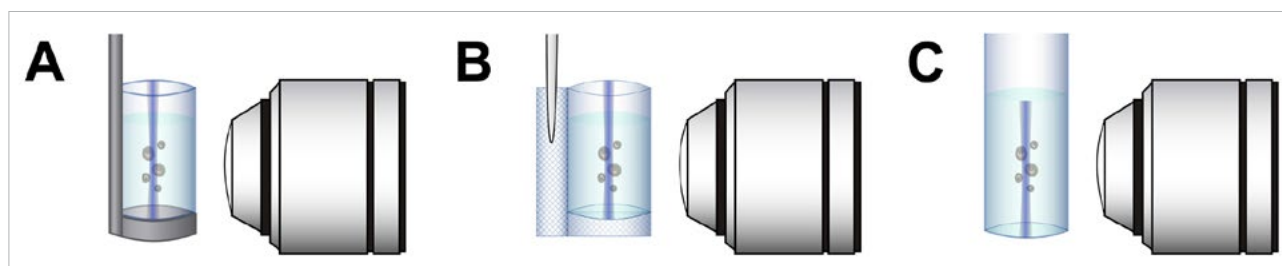

Fig. 10 Enclosed chambers for LSFM. Incubation chambers can be made by molding an agarose beaker that can be mounted on a simple plastic holder and loaded with the sample prior to imaging (A). Another solution is to create a chamber with a specific polymer with a refractive index close to water (for example PTFE or FPE) using heat or glue to seal the chamber to the needed size and volume, and attach it to a suitable holder (syringe, capillary etc...) (B). A PDMS, FPE tube or glass chamber can also be considered (C).

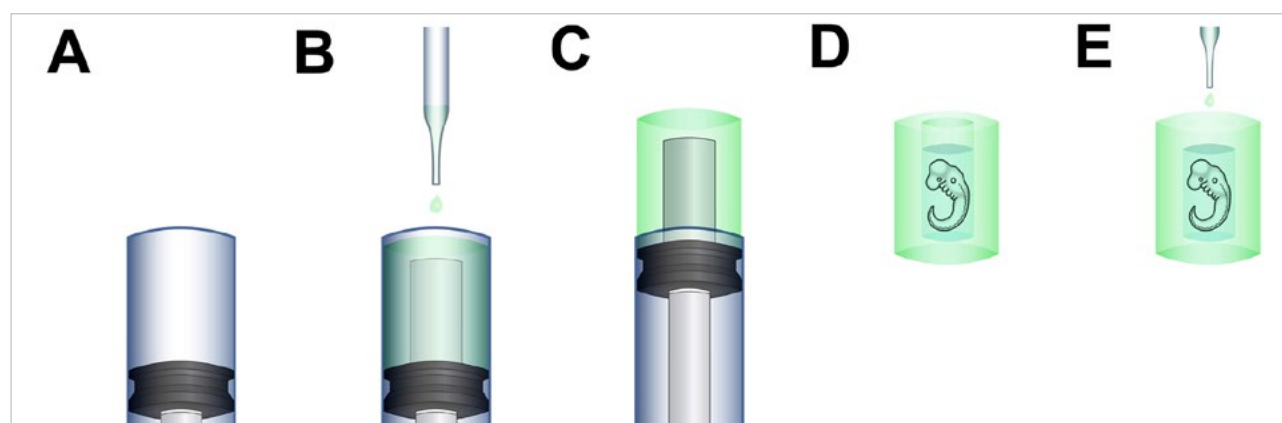

Fig. 11 Making and mounting an agarose incubation chamber. A modified syringe plunger is made by inserting a smaller diameter cylinder on to the plunger (A, B). The tube is molded by simply pouring the molten agent into this device (C). Once removed, the open end of the container (D) can be closed with agarose (E).

kept in a water-based buffer for later use. The gelling agent must be transparent, and although the use of agarose is possible, the concentration will depend on the size of the container walls and the inside chamber. It is recommended to use a higher concentration of gelling agent to ensure the stability of the container. We have used a 1ml syringe as a molding system and a concentration of 1.5 % agarose for the container molding. The stability is good and the degradation of the optical path is minimal. Higher agarose concentrations may generate aberrations. Another possibility is to use a polymer to make the chamber.

The polymer, similar to the gelling agent, must be transparent or at least have an optical index as close as possible to water or the buffer used during the experiment. The polymer is usually used as a sheet that can be formed as required. The other possibility is to approach commercial manufacturers to make polymer chambers at the specific sizes and lengths required. Fusing polymer sheets can be done using a welding iron with controlled temperature or a welding device use for melting

together plastic bags. As described in Fig. 12, the polymer foil is folded to an appropriate size. This can be made easier by using a guide or template, in this case a micropipette.

The polymer is fused together. The tube generated is finally fused together on the other side to make a complete container. The polymer chamber can be easily mounted on the LSMF by using a clip, a slotted metal capillary or glued to a micropipette. However, the last two options have the disadvantage of partially obscuring the field of view.

This technique has been successfully used to image living cells (Engelbrecht et al., 2007) and cell clusters (Pampaloni et al., 2007).

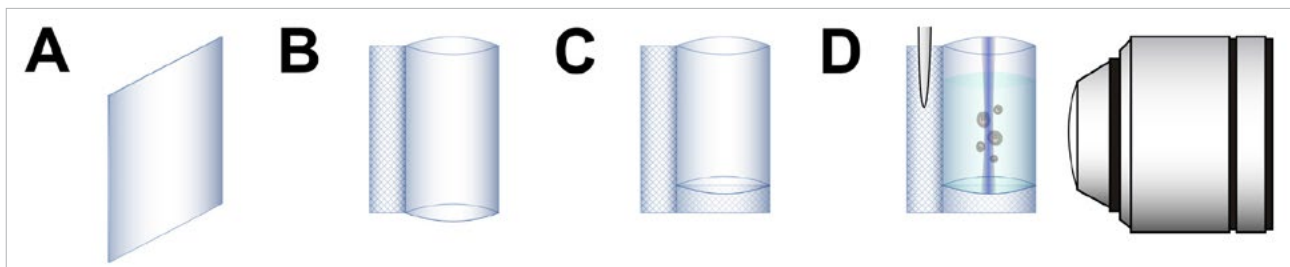

Fig. 12 Making and mounting an incubation polymer foil chamber. A piece of polymer foil (A) is folded and either heat- or glue-sealed to generate a tube of a predefined size (B). Excess foil can be removed or used to glue the tube on to a specific holder (capillary, thread, metal rod...) (D). One side of the tube can be then glued or heat-sealed to close the chamber (C). The polymer used must be suitable for microscopy and easy to seal. The chamber can be glued to a support, held by forceps, or inserted into a slit rod.

2.2.4 FEP Tubing

More recently, the availability of Fluorinated Ethylene Propylene (FEP) tube of different diameters has been successfully used for long term imaging of Zebrafish embryos (Kaufman et al., 2012). Here, we refer only to the paper by Anna Kaufmann, Michaela Mickoleit, Michael Weber and Jan Huisken in Development 139, 3242-3247 (2012) (“Multilayer mounting enables long-term imaging of zebrafish development in a light sheet microscope”) and emphasize the fact that the mounting method described in this article is fully compatible with Lightsheet Z.1.

2.3 Materials and Equipment

This section gives an overview on the materials and equipment for sample mounting and the sample chambers of Lightsheet Z.1. The generalization of the concept is also mentioned.

2.3.1 Sample Chambers

In Lightsheet Z.1, the sample is positioned within a chamber containing an aqueous solution. This chamber is tailored with O-rings to tightly fit the detection optics and avoid leakage. The upper part of the chamber is open to allow introduction of the sample. The bottom can be equipped with a Peltier Block or a Heatingblock (optional incubation). The remaining three sides are made in such a way that glass coverslips can be fixed allowing entrance of the light sheets from two sides and observation of the object by the user during the different steps of imaging using the appropriate software feature. The original chamber is made of medical steel, however, depending on the buffer used (salt, pH etc.), the experiment being performed (time lapse, live cell imaging etc.), there might be a need for more specific chambers. Carl Zeiss Microscopy provides the technical drawing of the sample chamber for Lightsheet Z.1 so that users can develop their specific sample chamber¹.

You can refer to the sample chamber section of this manual for further information. When designing a chamber for your particular application you must take into account the following points:

Transparency: user visual access, light sheet entry and exit routes, the distance of the coverslips for the light sheet – and the water filled space in between – are a crucial measure in the optics calculation of Lightsheet Z.1 system. To ensure the functionality of the system these have to be maintained when a custom made chamber is designed.

- Temperature control: heating devices, cooling devices
- Volume: size of the sample, buffer used (cost), drug treatment (cost)...
- Fitting: objective, illumination position, stage, heaters...
- Material: buffer, heater, sterilization, UV protection...
- Flow: flow entry and exit
- Size
- Cost

¹ Carl Zeiss Microscopy GmbH (hereinafter “we”) hereby informs you that we will warrant the specified and agreed performance of Lightsheet Z.1 system only if sample chambers are applied and used that either are delivered or explicitly approved by us.

The sample chamber design has been optimized to ensure the most established applications of Light Sheet Fluorescence Microscopy. Exceptional applications may require a slightly modified sample chamber design. In order to enable customized modifications of the existing sample chamber we also provide the corresponding CAD file and a technical drawing. We explicitly advise you that already minor deviations of the dimensions and tolerances specified in these documents will cause a significant loss of image quality and can potentially result in a liquid leakage. Therefore, you will not hold us or one of our affiliates liable for any damages caused by the employment of self-built or third-party-built sample chambers, the use of such self-built or third-party-built sample chambers will be solely on your own risk. Furthermore we want to inform you, that we will not render any assistance relating to the production and application of such self-built or third-party-built sample chambers.

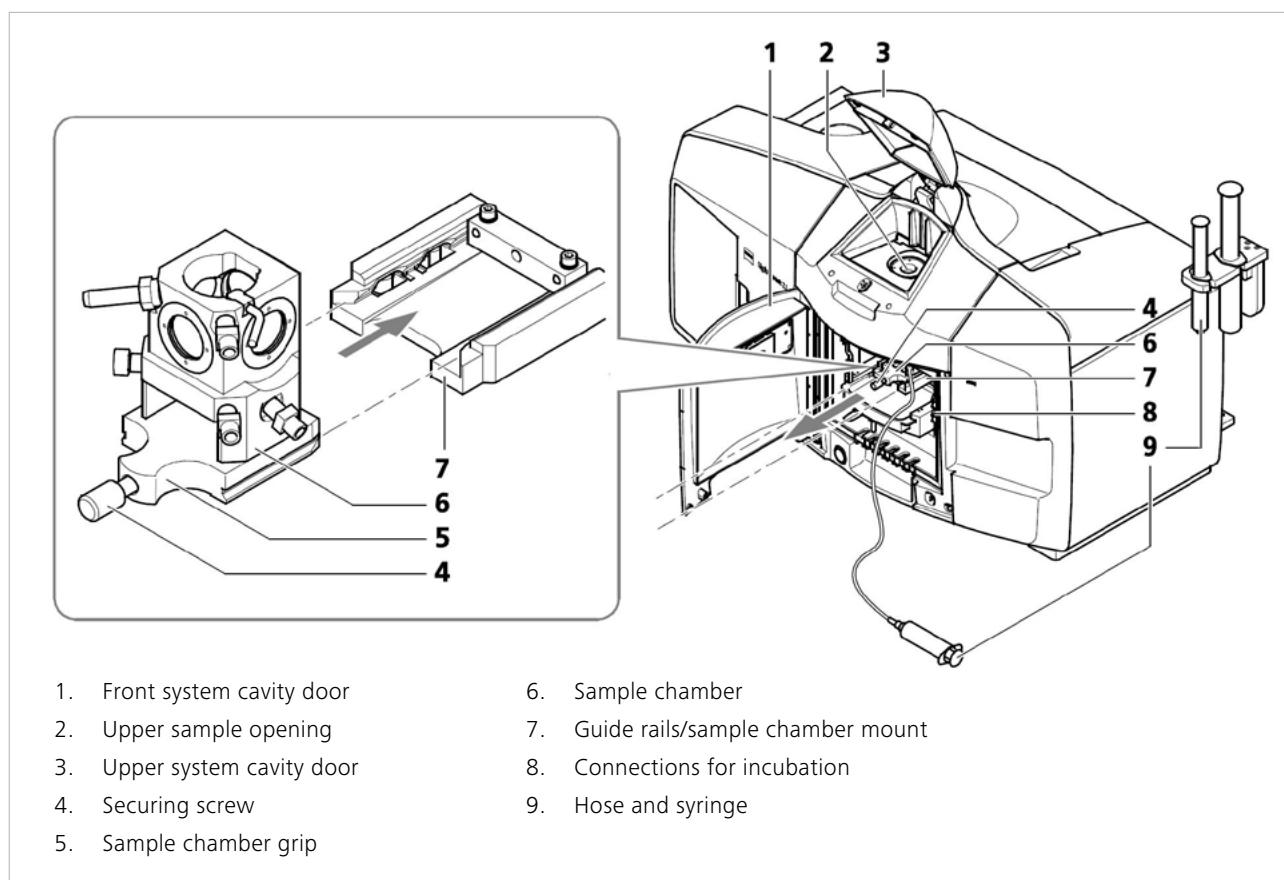

Fig. 13 Removing and inserting the sample chamber. *The chamber has five entry points allowing the positioning of the objective, the sample holder, the light sheet and the observation by the user. Heated chamber. The chamber can be equipped (optional) with a Peltier Block that can be tuned according to needs or a Heatingblock. For further details on the sample chamber handling, accessories, its cleaning and assembly please read the corresponding chapters of this manual.*

2.3.2 Molding and Mounting Supports

As described previously, there are several options to prepare a sample and therefore several options to manipulate and mount it. Initially, readily available products found in cell biology laboratories: syringes, capillaries or pipettes were used to mount samples. These components are all commercially available, cheap and convenient for LSFM sample preparation. However, they still need to be prepared for the specific needs. Plastic syringes exist in various sizes (0.2 ml, 0.3 ml, 0.5 ml, or 1 ml) and have tight plungers that easily allow pumping and movement of the agarose rod used to embed the sample.

They can also be used to hang the sample by effectively using the plunger and syringe body as forceps. The sample holder disc for syringes (Fig. 14/I and K) provided should be used in this case. Moreover, they can be purchased sterile for single use applications.

In the case of Lightsheet Z.1, the sample kit is provided with four types of color coded capillaries with matching plungers (Fig. 14/A and B) and color coded sleeves to fit perfectly each type of capillary to the sample holder (Fig. 14/C). The typical protocol of sample mounting is a two-step process of choosing carefully your sample mounting system based on your sample (size, agarose/sample ratio...) then to assemble it (e.g. plunger+tip+capillary) beforehand. Prepare it (e.g. sample + agarose) and insert it in the upper sample opening in Lightsheet Z.1 (Fig. 14/G and H).

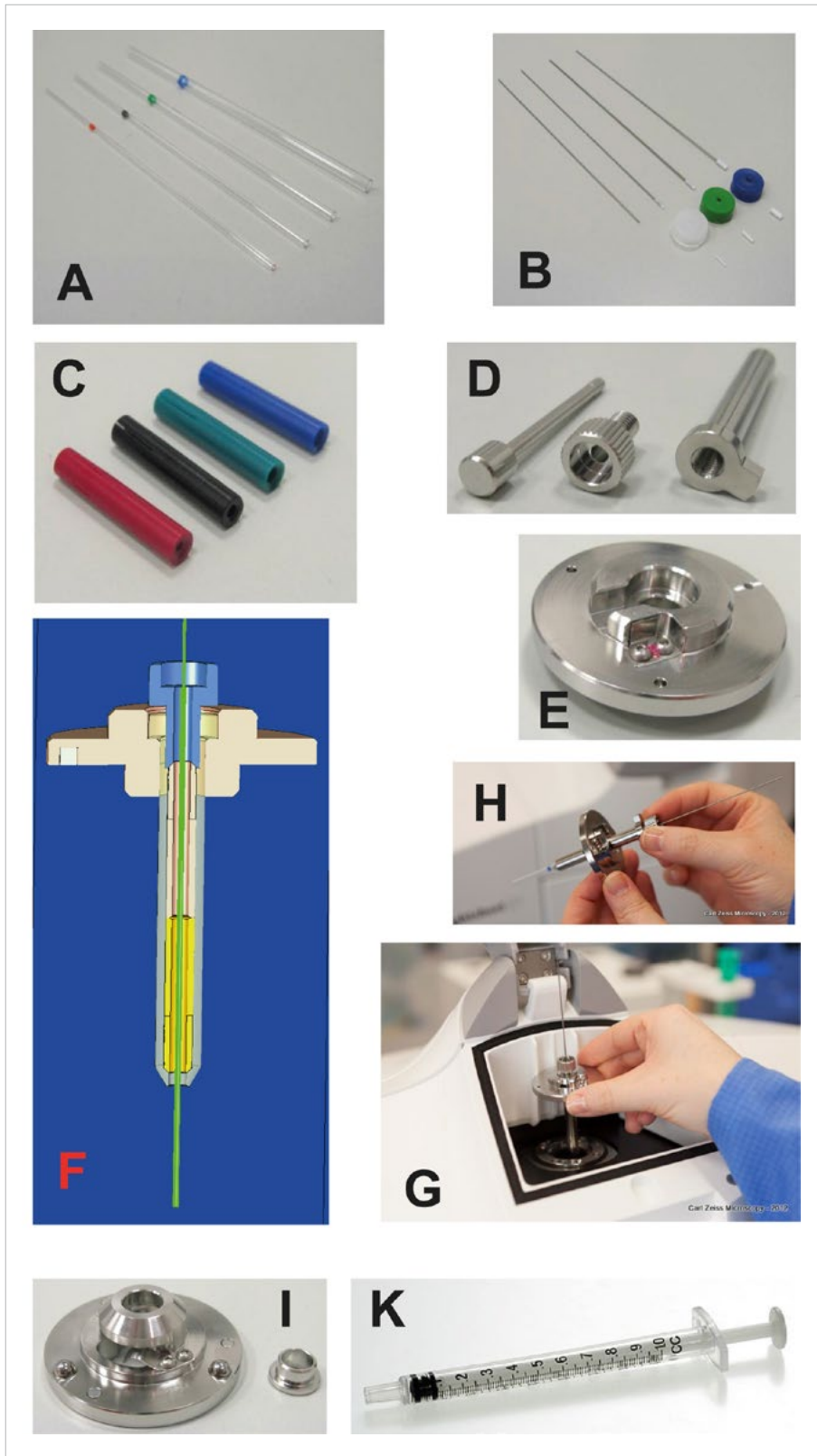

Fig. 14 Sample mounting accessories as part of the sample chamber and holder starter kit.

- A. Capillaries (inner diameter of capillary size 1 / ~0.68 mm, size 2 / ~1 mm, size 3 / ~1.5 mm, size 4 / ~2.15 mm)
- B. Specific plungers and Teflon tips for each capillary.
- C. Specific color coded sleeves to adapt each capillary to the sample holder (F).
- D. Sample holder stem for capillaries, clamp screw, ejection tool.
- E. Sample holder disc for capillaries
- F. Sample Holder diagram showing the capillary, the stem and disc of the sample holder.
- G + H. Sample holder handling and insertion in Lightsheet Z.1.
- I. Sample holder disc for syringes, adapter ring.
- K. Syringe (1 ml).

A few points must be taken into account when choosing a particular mount:

- **Compatibility.** This is a crucial issue. The mount must be compatible with the object you want to image (chemistry, temperature etc.), but it must also be compatible with the stage holder.
- **Stability** (mechanical, optical, chemical).
- **Tightness.** In the case of embedded samples, once the gel has solidified, the cylinder of gelling agent is pushed through the capillary out of the distal end by a plunger fitting into the capillary. The system must be air tight to avoid air entry leading to a displacement of the gel rod. The plunger can be sealed with a drop of wax, acrylamide or nail polish, i.e. anything that prevents the plunger and hence the agarose containing the sample from moving.
- **Cost.**

2.3.3 Sample Holder

Once the specimen is prepared and properly labeled, it is ready to be imaged. While in conventional imaging there is a suitable platform on which to place the glass slide or the chamber, in LSFM the object must be held from above via the sample holder. Depending on the size of the sample there are two different types of sample holders available: sample holder for capillaries and syringes (Fig. 14/C-F and I). Always use the minimal cylinder diameter necessary for your specimen size to avoid excessive amounts of agarose. The largest sample holder has been designed to accommodate a 1ml syringe that can be inserted from the top with a plunger that can be operated once the sample holder is mounted on the stage. Once inserted, the syringe is perfectly fitted to the sample holder as the two flaps used for injection fit the upper part of the holder. In this way the object support is well maintained, an essential issue for imaging and multiview imaging as the object is moved through the light sheet by the stage. Capillaries have been extensively used to image small embedded objects, as hooks for very large objects, and as support for enclosed objects, so the capillary has become commonly used for LSFM sample embedding.

Capillaries are made of glass. They can break. They

- ! will slide when wet. Please handle them with care and dispose of them properly.

2.3.4 Gels and Polymers

Gelling agents are commonly used for preparing semi-solid or solid tissue culture media. Gels provide support to tissues growing in static conditions. The gelling agent usually has several properties. In particular, it does not react with media constituents, is not digested by enzymes, and remains stable at all incubation temperatures. Gelling agents are very versatile and useful tools in LSFM as they allow easier sample preparation. This section will present in more detail the properties, advantages and disadvantages of two well-described gelling agents and provides an additional list of gelling agents.

Agarose

Agarose is a complex carbohydrate polymer material, generally extracted from seaweed. It is used in chromatography and electrophoresis as a medium through which a substance can be analyzed by separating it into its components. The molecules are extremely water-soluble due to their large number of hydroxy groups, and solutions tend to be low-melting point aqueous gels. A wide range of different agaroses, of varying molecular weights and properties are commercially available. These include low melting types, (for example, Agarose Type VII, low melting temperature: gelling temperature below 30 °C, melting temperature above 65 °C) which can be used if the sample is sensitive to high temperatures. Interestingly, the refractive index of the low melting type is lower than that of normal agarose. However, to obtain the same strength, a higher concentration needs to be used. With a concentration of 1 % (w/w) the low melting point agarose has the same stability as a 0.5 % agarose (normal). The refractive index at this concentration is still lower than that of normal agarose, minimizing distortions when imaging. In our laboratory, we preferentially work with agarose as it is easy to handle, has good optical properties and is not expensive.

Gelrite

Gelrite gellan gum is a self-gelling hydrocolloid that forms rigid, brittle, transparent gels in the presence of soluble salts. Chemically, it is a polysaccharide comprised of uronic acid, rhamnose, and glucose. It is produced by the bacterial strain S-60 of *Pseudomonas elodea*. Gelrite is a trademark of Merck and Co, Inc (Rahway, NJ), Kelco Division, USA. One advantage of Gelrite is the lower scattering of light compared to an agarose gel with the same stability. It has a higher index of refraction but less scattering compared to agarose. Gelrite has a

consistent batch-to-batch quality due to a stringent control of the fermentation process. Only half the amount of Gelrite is required for the same purpose. It hydrates rapidly and gel setting can be easily controlled. The stability of the gel depends on the concentration of divalent cations (Mg²⁺, Ca²⁺) therefore a gel made with Gelrite and pure water is unstable compared to a PBS- (buffer) based gel. Polymerisation is faster compared to agarose, which might be advantageous for some applications. The temperatures for gelling and remelting are similar to that of agarose. Additional list of gelling agents:

- Galactan
- Agar
- Gelatin
- Carrageenan
- Alginate
- Phytigel™
- Agargel™
- Transfergel™

2.3.5 Hydrogel Preparation

Every gelling agent is prepared following specific protocols that vary widely from supplier to supplier, and from laboratory to laboratory depending on the final application.

We will not try to cover every single one of these but rather give a simple protocol that we have been using in our laboratory to prepare embedded samples in agarose as a gelling agent. The preparation is done as follows:

1) Preparing a 1 % low melting agarose gel.

Weigh 1 gram of low melting point ("low gelling") agarose ("Agarose Low Melt" (no 6351.1 from <http://www.carlroth.com>) and place it in a flask. Add 100 ml of solvent (water, PBS) to the flask. Swirl to mix the solution. Place the flask in the microwave. Heat above 95 °C until the solution is completely clear and no small floating particles are visible. Do not allow the agarose to boil over as this will affect the final agarose concentration. Swirl the flask frequently to mix the solution, prevent the agarose from burning, and prevent boiling retardation.

Wear heat-protective gloves when handling the flask.

- ! The agarose can be also sterilized for sterile use (cell culture). It is also possible to remove dissolved air bubbles using a vacuum pump.

2) Cooling the gel

Once molten the gel is left to cool to 37 °C (or just above gelling temp - read the material properties sheet) in a water bath or on a heating plate. It is very important, especially for sensitive samples, to ensure that the agarose is at 37 °C before use.

Note: Alternatively, you can aliquot your agarose solution into 1 ml or 2 ml Eppendorf tubes for later use. Label them and store them in a cool and dry place. In this case, each aliquot can be liquefied using a heating block (80 °C – 90 °C) then transferred to a heating block at 37 °C.

3) Using the gel

At this stage follow the examples described in the section dealing with embedded sample preparation. Avoid bubble formation during handling and pipetting as they will impair the embedding process. Work quickly as the low melting point agarose will polymerize rapidly as it was kept at 37 °C close to the gelling temperature.

4) Polymerization of the gel

Let the gel polymerize. Avoid contact with any water-based solution as it will dilute the gelling agent solution. The process of polymerization can be accelerated by cooling down the embedded sample (cold water, fridge...) – but keep in mind that this might affect viability of a living sample.

5) Using the prepared sample

Once fully polymerized, the embedded specimen can be manipulated, but keep in mind that it is a gel and therefore fragile. Avoid any kind of friction, or shock etc. As it is a water-based object it must be kept wet at all times to avoid drying out and damaging the sample. Moreover, many types of gel may change their properties over time (e.g. swelling), and this can result in loosening of the gel in the support. It is therefore important to use your sample as soon as possible and monitor its quality over time if you plan to reuse it.

2.4 Fixation and Fixatives

Many experimental samples will require fixation prior to imaging. The goal of fixation is to maintain cellular structure as close as possible to the native state. Proper fixation typically facilitates immunohistochemical analyses if desired, and is an important step prior to further processing. Specialized fixation procedures and processing may be required for certain tissues (e.g. bone de-calcification) or preserving specific target antigens. The processing of most samples begins with fixation to preserve morphology. A fixation method must take into account two things: the preservation of cellular 3-D structure and maintenance of good access to antigenic sites. The goal is to preserve sufficient cellular organization to allow identification of the features of interest, but not to destroy the antigenicity of the target. Fixation is also frequently combined with permeabilization to allow the staining solutions used in later steps access to the cellular interior. Commonly used histological methods of fixation and permeabilization often consist of treating the cells with solvents, such as methanol. While these methods are rapid-acting precipitating fixatives, they are also good permeabilizing agents, but have one significant negative consequence: cellular shrinkage. The degree of shrinkage may be almost insignificant for monolayers of cells, but will distort tissue samples dramatically. To take full advantage of the three-dimensional reconstruction capability of the LSFM microscope, the use of a fixative that does not destroy *in vivo* structure and organization is imperative. It is important to remember that different specimens may require different fixation methods. Testing and optimizing for each new sample type will ensure that the best balance between preservation and labeling is obtained. Fixing and permeabilizing your cells affects the cell morphology and the availability of the antigen you are trying to detect. You may get different results with different reagents, times and concentrations, hence the need for protocol optimization. The distortion of cell morphology is something to bear in mind when interpreting the images.

2.5 Stains and Staining

In LSFM, like in any microscopy technique using fluorescence, the sample can be labeled using specific fluorescent dyes, fluorescent proteins or fluorescently coupled antibodies. Two basic techniques are generally used: direct labeling and indirect labeling. Both labeling methods are suitable for LSFM microscopy. Direct labeling consists of using fluorescent proteins, fluorescently labeled primary antibody or a dye that cause the structure of interest to become fluorescent. Advantages of this method include speed and ease of application. A potential disadvantage is lack of sensitivity (low signal intensity). The indirect method involves binding a primary antibody to the epitope of interest, followed by a fluorescently labeled secondary antibody. The main advantage of using this technique is the great amplification of signal possible through an antibody cascade. The disadvantages include increased complexity, the method is more time consuming, and there are often problems with non-specific antibody reactions.

2.5.1 Choosing a Fluorescent Label

The choice of label depends upon the available equipment on your LSFM set-up (lasers, filters) and the availability of certain fluorescent protein variants, fluorochromes conjugated to required antibodies for use in multiple labeling schemes. In general, the laser lines available dictate which fluorophores or fluorescent proteins can be used. Recent advances in biochemistry have created new families of fluorophores with very favorable signal-to-noise and quantum efficiency (QE) properties. Similarly, many laboratories have developed a wide variety of fluorescent proteins that span the spectra from GFP² to Plum.

² Flood P.M., Kelly R., Gutiérrez-Heredia L. and E.G. Reynaud
School of Biology and Environmental Science, University College Dublin, Belfield, Dublin 4, Dublin, Ireland

2.6 Antifading Agents

Fluorescently labeled cells and tissues exhibit a characteristic photobleaching curve in response to excitation by the light. Much of the photobleaching can be attributed to the generation of free radicals. The use of free radical scavengers has been shown to decrease the rate of photobleaching. Common scavengers include n-propyl gallate, p-phenylenediamine and DABCO (1,4-diazobicyclo-(2,2,2)-octane). Live systems have been reported to reduce photobleaching in the presence of vitamin C or Trolox. As the LSM technology reduces greatly the phototoxicity and photobleaching effects during imaging, we never encounter samples that require the use of antifading agents so far. However, some applications may require the use of radical scavengers during long time imaging of GFP expressing samples as repeated exposure may lead to a regular increase of the free radical contents, which might affect its behavior over time.

2.7 Cleaning, Labelling and Storing Samples

One important point about samples is their handling. In the case of LSM, all the samples are three dimensional objects that are mounted to be imaged in a chamber containing water based medium. They must then be maintained in a moist environment. Once prepared and prior to imaging, the samples can be held in a filled beaker or Falcon tube filled with the appropriate medium, e.g. water, PBS (Fig. 15).

One simple solution we have developed in the laboratory is to use a beaker filled with the right buffer. The samples are maintained by using plasticine on the beaker border. An alternative is to cover the top of the beaker with an aluminum foil and accommodate the sample holders such as the 1 ml syringe by drilling a hole in the foil. This handling technique limits evaporation. More advanced holders can be designed and manufactured according to need. You will find a couple of examples that we have made in our laboratory² to handle various size of sample embedding containers. They include a water tank that keeps the samples moisture at all time. They are stable and can be easily move from the laboratory to the microscope as well as stored in the fridge.

As in LSM there is no need for oil or any specific chemical for imaging, the cleaning of samples is not necessary. However, you can rinse the sample within the capillary or syringe with water or your specific buffer after imaging if the chamber was containing particles, bacteria or other chemicals (dyes, drugs etc.).

Labeling the samples can be an issue as it can be tricky to mark the name of every sample on the embedding container (capillary, syringe...). A simple marking technique is to use tape roll around the syringe plunger or the capillary. This must not affect the handling of the sample on the microscope.

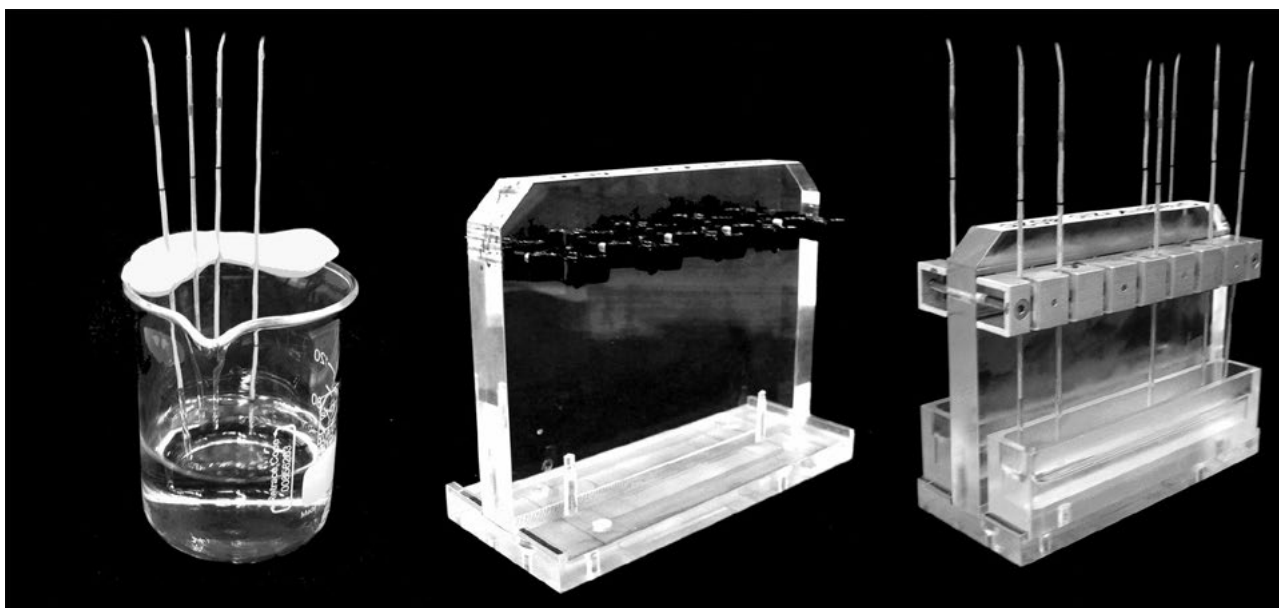

Fig. 15 Supports for sample embedding containers. Support are used to hold three dimensional objects that cannot be held flat easily. Moreover, embedded samples need to be kept in buffer to avoid gel shrinkage or sample damage. A simple system is to use a beaker filled with PBS and place plasticine on the upper border to support the sample embedding container (A). More elaborate supports can be made using clips of different sizes for holding syringes (B) or even capillaries (C).

Another approach is to number the sample and to register the detail on a lab book. However, this can be a problem if you store many sets of samples in the same fridge day after day.

Sample preparation techniques usually allow long time storage (paraffin embedding, slides...). As long as a few basic rules are followed (keeping away from light, temperature...) they can be kept up to years. In the case of LSFM, the samples are imaged in a water environment and must be always kept wet, even for long time storage. This can be a challenge. Usually, we keep fixed samples in the fridge using a sample embedding container support and we refill the buffer tank from time to time. However, we never kept samples for more than a month under such conditions. A longer storage possibility is to use a water tight container where the samples are kept with enough water not to dry out. One point to consider is the way the sample was prepared. Embedded samples may weaken with time as some gels may not maintain their strength over time at 4 °C. Hooked samples may as well be loosening and fall from their support. It may be better to unhook them and store them in a different type of container.

3 SPECIFIC EXAMPLES OF SAMPLE PREPARATION

In order to make this sample preparation section as useful as possible the following pages describe mounting techniques for specific samples, in particular describing the equipment needed, step by step protocols and illustrations based on our own laboratory³ experiences.

- Fluorescent beads are used for later Landmark Registration processing of acquired Multiview data, and should be included during embedding of samples of interest. Prepare agarose as described in section 3.1 Preparation of Fluorescent Beads accordingly.

3.1 Preparation of Fluorescent Beads

Samples with fluorescent beads are often used to characterize the imaging properties of a microscope such as the LSFM. Using a reproducible sample is an important tool to calibrate the instrument. This protocol describes how to handle fluorescent beads and to prepare optimal concentrations to image with an LSFM.

Equipment and reagents:

- Fluorescent beads
- 1 % Low Melting Point (LMP) Agarose in deionised water
- Capillary (Size 4, Blue, #701910, BRAND GmbH)
- Sonicator
- Heating block- Vortex

Method

1. Vortex the bead solution to make a homogeneous dispersion.
2. Dilute a small volume of the bead dispersion in deionized or distilled water to a concentration 100x higher than the one desired for the specimen. Depending on the size of the beads and the magnification required it is first necessary to calculate the bead-agarose ratio (see below).
3. Sonicate the dilution for 5 minutes at maximum power.
4. Prepare a liquid agarose solution of a chosen concentration (0.5 % - 1 %) and cool it down to just above the gelling point (usually 38-40 °C).
5. Mix diluted fluorescent beads with the agarose in ratio 1:100 and vortex the mixture. Use a pipette or a capillary (by sucking in and out the liquid agarose several times) to mix the bead solution and the agarose thoroughly.
6. Insert an appropriate plunger and Teflon tip.
7. Push the plunger through the capillary, so the front end of the plunger is sticking out of the capillary by a bit before entering the liquid agarose and sucking the agarose in. This will avoid air bubble formation at the plunger.
8. Suck in the agarose/beads by pulling the opposite end of the wire/plunger.
9. Let the gel polymerize (approx. 5 minutes) before imaging.
10. Make sure that only a very short part of the agarose lock is pulled out of the glass capillary during image acquisition.
11. When multiple views are recorded, it is best to image from the centre of the agarose block.

Beads should be fluorescent in the part of the spectrum you would like to analyze for 1 channel systems. With Lightsheet Z.1, a two channel system, one can use one channel for the beads (e.g., red) and one channel for the specimen label (e.g, GFP.) Fluorescent beads covering whole

³ Flood P.M., Kelly R., Gutiérrez-Heredia L. and E.G. Reynaud
School of Biology and Environmental Science, University College Dublin, Belfield, Dublin 4, Dublin, Ireland

visible spectrum are nowadays easily available from various different suppliers (e.g. Polysciences, Invitrogen, Estapor/Merck etc.). In our case, the density of the fluorescent beads is chosen to end up with several hundred beads in the imaged volume. For example, for a 40x magnification lens the volume of interest is around $(200\ \mu\text{m})^3 = 8 \times 10^{-6}\ \text{ml}$. If the fluorescent beads are shipped as a solution of 5×10^{13} particles/ml, you have to dilute them 1:10⁶ in agarose to have approximately 400 particles in the volume of interest. Having too few of them (less than 100) in the three-dimensional image will give you no or poor processing results, while too many of them (more than 1000) might considerably increase processing time without a significantly improving the final results.

Moreover, a gel with sufficient stiffness but minimal impact on the image has to be used to immobilize the beads. 1% low-melting agarose (Sigma, Type VII) is being routinely applied for lenses with numerical apertures up to 0.8 NA. For 1.0 NA objective lenses and above, a more diluted (e.g. 0.5 %) gel must be used to minimize gel-caused image aberration.

3.2 Preparation of a Medaka Fish Embryo (*Oryza latypes*)

Embryos have been extensively used for many decades to study developmental mechanisms as well as diseases. They can range from micrometers to centimeters depending on the species used (frog, fish, fly, worm, etc.). This protocol applies to most embryos. The important point is the temperature. The embryo must not be damaged by temperature shock during embedding. Moreover, the embryo should not be constrained by the stiffness of the gel. This may impair its normal development.

Equipment and reagents

- 1.5 % Low Melting Point (LMP) Agarose in E3 (Fish buffer)
- Mesab/Tricaine 0.4 % stock (3-Aminobenzoic Acid Ethyl Ester)
- Capillary (Size 4, Blue, #701910, BRAND GmbH)
- Electrical thread (1,6 mm) or plunger
- Heating block

Method

1. Select embryos for imaging, dechorionate. Melt 1.5 % LMP agarose, aliquot 0.5 ml into a 1.5 ml Eppendorf tube. Add 150 μl of Mesab to ensure that the embryos do not move during imaging. Invert the tube to mix and allow agarose to cool to 40° C.
2. Add the embryo to the tube containing agarose using a Pasteur pipette, transferring as little buffer as possible.
 - Add the embryo to the Eppendorf tube as a drop on the tube wall. If necessary remove the extra buffer with a yellow tip before dropping the embryo into the agarose. Or transfer the embryo to an empty Eppendorf tube, remove all medium and add the liquid agarose.
3. Let the embryo fall to bottom of the Eppendorf tube. Insert a capillary into the tube and suck the embryo into it by pulling out the thread or plunger like a syringe piston.
 - When sucking up the agarose, make sure that initially the plunger is sticking out of the capillary within the liquid agarose, to avoid air bubble formation. Furthermore leave some space between the plunger and the sample (see Fig. 16/D)
4. Allow the agarose to harden and place the capillary in a stand in water or PBS.
5. Mount on the capillary sample holder prior to imaging.

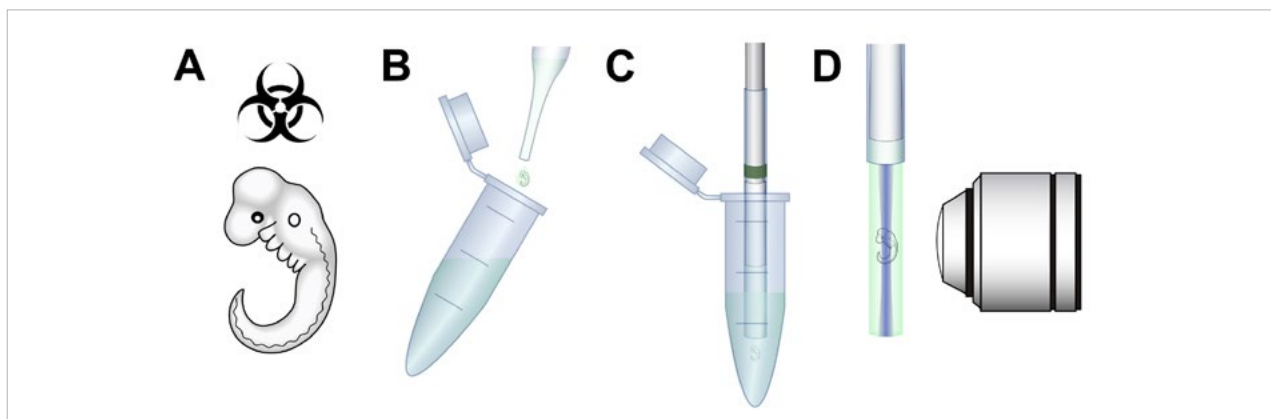

Fig. 16 Mounting an *Oryza latypes* embryo. (A) The embryo is prepared (labelling, drug treatment, dissected...) (B) The embryo is deposited on the side of the Eppendorf tube and the excess of water is removed with a pipette. (C) The embryo is dropped into the agarose and pumped into the capillary. (D) The embryo can be imaged.

3.3 Preparation of a Fly Pupa (*Drosophila melanogaster*)

Some type of embryos are hydrophobic once dissected and cannot be mounted using the technique described above as they will float on the agarose and will be impossible to embed. The following protocol is suitable for this type of embryo such as fly embryos or pupas.

Equipment and reagents

- *Drosophila melanogaster* pupa or embryo
- 1 % Low Melting Point (LMP) Agarose in water or PBS
- Capillary (Size 4, Blue, #701910, BRAND GmbH)
- Heating block (90 °C and 40 °C)

Method (see Figure 17)

1. Choose a pupa *Drosophila melanogaster*. Melt 1 % LMP agarose, aliquot 0.5 ml into a 1.5 ml Eppendorf tube. Invert the tube to mix and allow agarose to cool to 40° C.
2. To allow sample preparation the pupa must be submerged in agarose by pouring it directly on top of it in a large drop of molten low melting point agarose.
3. The pupa can then be pumped into a capillary as previously described.
4. The insect can then be imaged.

3.4 Preparation of a Plant Root (*Arabidopsis thaliana*)

Plant research is an important field of investigation using plants as model systems. They are three-dimensional objects that are difficult to image fully and are usually dissected and sliced before being imaged and analyzed. This protocol has been used to mount complete young *Arabidopsis thaliana* plants for imaging root development directly on the microscope.

Equipment and reagents

- 1 % Low Melting Point (LMP) agarose in plant buffer
- 1 ml syringes
- *Arabidopsis thaliana* seeds
- Heating block

Method (see Figure 18)

1. Several agarose beakers are prepared as described in the enclosed sample section.
2. Instead of pushing out the plunger to extract the agarose beaker, the plunger is pulled in to the end of the syringe where it can be released leaving the beaker inside the syringe.
 - You need to make a long walled beaker to avoid inconvenient breakages and leakages that may be caused by the following steps.
3. A seed of *Arabidopsis thaliana* is put at the bottom of the beaker.
4. The beakers are kept in the syringe in a humidified and well lit chamber to allow seed germination.
5. Once the root is visible within the bottom part of the beaker, a normal plunger is inserted in the top part of the syringe, where the open part of the beaker is present.
6. Push down the beaker into the syringe until the root can be seen outside of the syringe cylinder
7. The beaker is mounted in the sample chamber filled with distilled water or plant growth media at room temperature.
 - As the plant depends on light to grow long-term imaging must take into account the illumination of the leaves between imaging sessions.

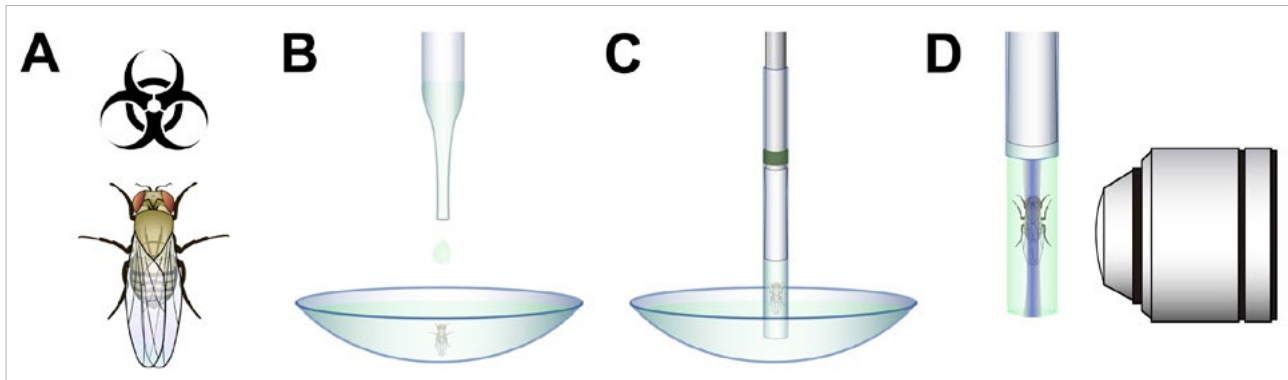

Fig. 17 Mounting a *Drosophila* pupa. (A) The pupa is prepared (labeling, drug treatment, dissected...) (B) The pupa is deposited in a watch glass and covered by melted agarose to embed the hydrophobic pupa. (C) The pupa is then pumped into the capillary. (D) The pupa can be imaged.

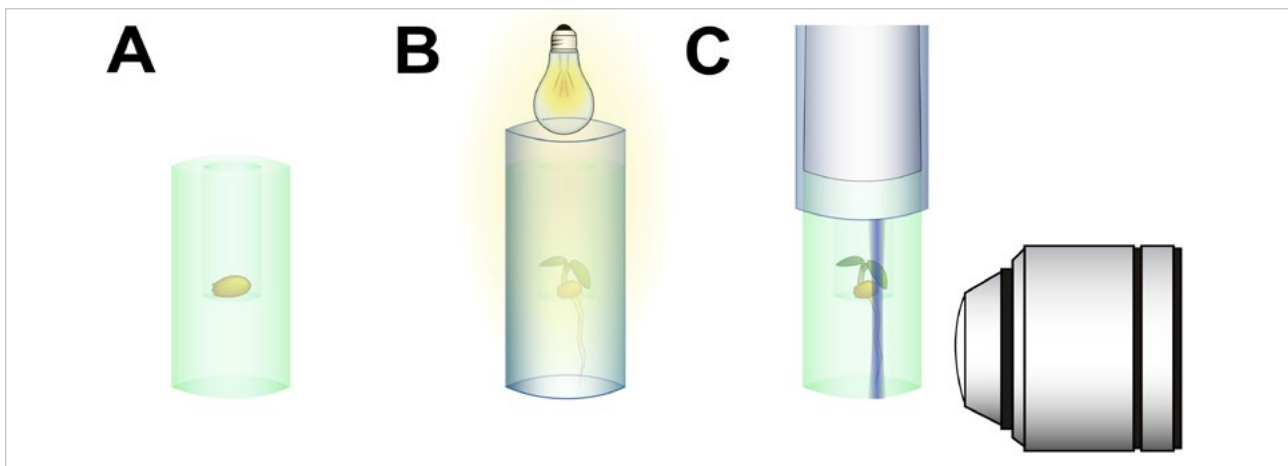

Fig. 18 Mounting an *Arabidopsis thaliana* root. (A) An *Arabidopsis thaliana* seed is positioned at the bottom of an agarose cylinder (B). After a few days of development, the root can be seen in the agarose cylinder bottom. (C) The agarose cylinder is pushed out of the syringe for imaging.

3.5 Imaging Cell Cysts in an Extracellular Matrix Gel

Live imaging of cells has been a major tool in cell biology. For this, cells must be maintained in optimal conditions during the complete time of the experiment. The incubation options for the Lightsheet Z.1 are described in another section of this manual (CHAPTER 1 HARDWARE). However, cells must be mounted in a way that allows them to hang in front of the objective from above. This protocol describes one way of imaging MDCK cells that naturally form cysts when grown in an extracellular matrix.

Equipment and reagents

- MDCK cells grown in an extracellular matrix (Matrigel, ExtraCell etc.)
- 1.5 % Low Melting Point (LMP) Agarose in PBS

- Modified plunger
- Sealing device
- Slitted capillary
- 1 ml syringe
- Capillary holder
- Heating block
- Polytetrafluorethylene foil or FPE tube

Method

1. An agarose beaker or a polymer foil chamber is prepared as previously described in the section 2.2.3 Enclosed Samples.
2. MDCK cysts are grown in an extracellular matrix gel.
3. Cells can be stained at this stage with live markers (nuclear, mitochondrial, lysosomal etc.) before mounting.

4. Cells within the gel are transferred into the chosen chamber (agarose, polymer) and mounted in a 37 °C and CO₂ chamber on the LSFM using a cut tip to limit shearing damage.
 - If cells are grown in a different manner it is possible to mix them with a supporting gel prior to loading into a chamber. They can also be grown within the gel already present in an incubation chamber. This limits damage, shear and temperature changes during sample preparation and handling.
5. The agarose incubation chamber is mounted on a specific holder. The polymer chamber can be either clipped or glued to a supportive holder.
 - Eukaryotic cells are highly sensitive to environmental change (temperature, pH, osmotic pressure etc.). The transfer steps must be rapid and carried out in a sterile manner (wherever possible) especially for long term time lapse experiments. It is important to be gentle and use cut tips and pre-warmed materials at all times, including the sample chamber.
6. Monitor the cell status during imaging to check viability and changes.

3.6 Immunostaining and Preparation of MDCK Cell Cysts

Immunofluorescence allows highlighting of specific proteins or structures using specific antibodies. This protocol is used to perform immunofluorescence on cysts which are three-dimensional cell structures that can be grown in extracellular matrix gel such as collagen.

Equipment and reagents

- 1.5 % Low Melting Point (LMP) agarose in water or PBS
- Capillary (Size 4, Blue, #701999, BRAND GmbH)
- Electrical thread (1.6 mm) or plunger
- 4 % paraformaldehyde solution
- Antibodies (primary and secondary)
- PBS
- Triton X-100
- Bovine Serum Albumin (BSA) or Foetal Calf Serum (FCS)
- Heating block

Method

1. MDCK cell cysts grown in extracellular matrix are collected and centrifuged at 500-1000g to pellet the cysts with the gel.
2. The supernatant is removed and replaced with 4 % paraformaldehyde and incubated for 15 minutes on a wheel or rocker to efficiently mix the gel pellet within the fixative.
3. The gel is pelleted and the supernatant is replaced by 0.1M glycine to quench the paraformaldehyde, and then incubated for 10 minutes.
4. The gel pellet is washed twice with PBS (500-1000 g, 5 minutes).
5. The pelleted cysts are permeabilized with PBS/1 % Triton X-100 for 10 minutes on a wheel or rocker to efficiently mix the gel pellet.
6. The gel pellet is washed twice with PBS (500-1000 g, 5 minutes).
7. The gel is incubated for 10 minutes in PBS/1 % FCS on a wheel or a rocker to block the extra epitopes and efficiently mix the gel pellet.
8. The gel pellet is incubated with the primary antibodies at the concentration indicated by the supplier, using a wheel or rocker to efficiently mix the gel pellet.
9. The gel pellet is washed twice with PBS (500-1000g, 5 minutes).
10. The gel pellet is incubated with the secondary antibodies at the concentration indicated by the supplier, using a wheel or a rocker to efficiently mix the gel pellet.
11. The gel pellet is washed twice with PBS (500-1000 rpm, 5 minutes).
12. The cysts can be stained at this stage with Hoechst to label the nuclei.
13. The gel is pelleted and as much of the supernatant as possible is removed.
14. The gel pellet is mixed with low melting point agarose, mixed and pumped into a capillary.
 - The extracellular gel tends to clump once fixed and may stay as one piece when mounting. Care should be taken to quickly but efficiently resuspend the gel.
15. Allow the agarose to polymerize.
16. Fill the chamber with PBS prior to introduce the sample for imaging.

3.7 Preparation of a Whole Mount of a Mosquito (*Anopheles gambiae*)

Adult insects are very large objects that can be up to 5 cm long. Moreover, they have an exoskeleton made of chitin which is hydrophobic and autofluorescent. This characteristic allows imaging without labeling by simply using the chitin autofluorescence to image the insect surface. This protocol applies to every type of adult insects as well as for various type of plankton.

Equipment and reagents:

- An adult *Anopheles gambiae*
- 1.5 % Low Melting Point (LMP) agarose in water or PBS
- 1 ml syringe (BD Biosciences)
- Ethanol (70 %)
- Glycerol (50 %)
- Sucrose
- Heating block

Method

1. Choose an adult *Anopheles gambiae* and immobilize it by cold treatment. Melt 1.5 % LMP agarose, aliquot 0.5 ml into a 1.5 ml Eppendorf tube. Invert the tube to mix and allow agarose to cool to 40° C.
2. To avoid bubble formation on the insect surface that will affect imaging, the insect must be treated either with ethanol 70 % (animal death) or using 50 % glycerol or 1 M sucrose to cover the hydrophobic chitin surface prior to embedding (Fig. 19/B).
3. The syringe is prepared as previously described and filled with molten low melting point agarose (40 °C).
4. The insect can then be inserted into the agarose cylinder and aligned using a needle or forceps (Fig. 19/C).
5. The insect can then be imaged (Fig. 19/D).

This technique can be applied to any insect or similar type of organism possessing an exoskeleton. Depending on the animal part to be observed the insect can be aligned differently or dissected prior to embedding (head, wings, guts, salivary glands...).

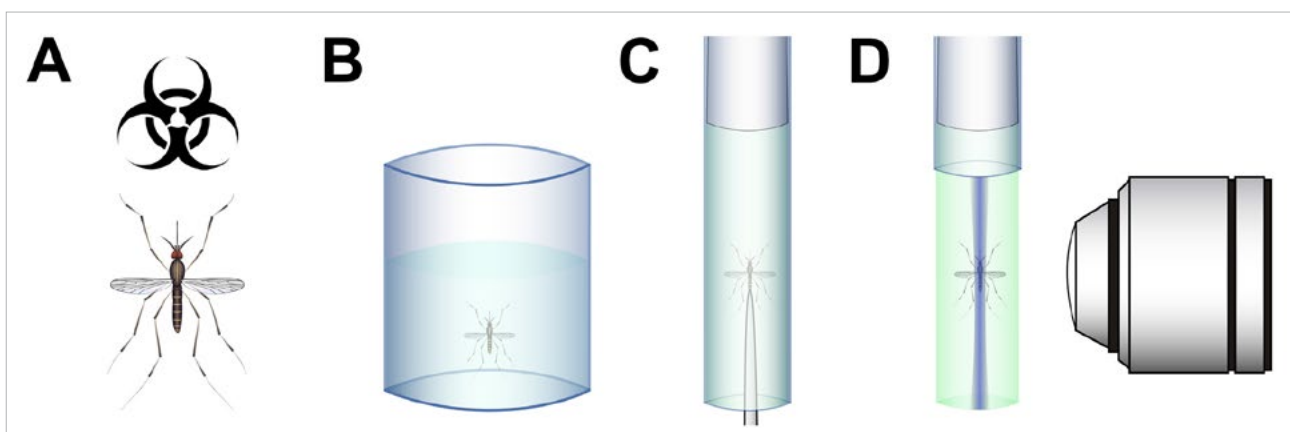

Fig. 19 Mounting a complete adult *Anopheles gambiae*. (A) The insect is paralyzed. (B) The chitin surface is treated using 70 % ethanol. (C) The insect is positioned within the melted agarose. (D) The mounted insect is ready for imaging.

4 TIPS, TROUBLESHOOTING AND ADDITIONAL INFORMATION

4.1 Tips

Protocols

As a general rule, follow the protocol carefully and try it out well in advance as you may encounter difficulties and missing parts (chemicals...) that may hinder you to use the sample straight away. The protocols presented in this section are not the ultimate solution for every problem. They can be improved and adapted to your need. If you encounter a problem, check the scientific literature and the other protocols presented and see if you can find a tip that you may apply to solve your problem. Be creative.

Safety

Please refer to the safety instructions provided with Lightsheet Z.1.

Setup Requirements and Maintenance

For optimal performance of Lightsheet Z.1, please check the Setup Requirements information delivered with the system. For information about maintenance and cleaning any part of Lightsheet Z.1, including the optics, please refer to section 2.7 Cleaning, Labelling and Storing Samples.

Refractive index mismatch

Light is refracted when it crosses the interface between two media of differing refractive indices (RI). Mismatching the refractive index of the objective immersion medium and mounting medium is one of the main causes of image degradation in microscopy. Refractive index mismatch results in stretching/compression of the z-axis. Also, spherical aberration is worsened by axial spreading of the point-spread function (PSF) resulting in reduced axial resolution. This phenomenon is exacerbated with depth and with a high numerical aperture objective, serious problems arise when imaging deeper than 10 μm into an aqueous sample. The mounting medium and the immersion medium should be matched. It is not a major issue in LSFM but this has to be considered when filling the imaging chamber in regard to the sample preparation technique, especially for embedding as gelling agents are used.

4.2 Troubleshooting

Common problems

LSFM is a fluorescence microscopy technique so many troubleshooting guidelines from other microscopy techniques apply here as well. Do not hesitate to ask experts in the field, check the literature, as well as internet resources that may provide you with a more detailed solution to the problem you have encountered. Also check with your Lightsheet Z.1 application specialist from ZEISS for FAQs and tips for troubleshooting.

Sample image is unclear, blurred or has insufficient contrast.

- This can be a simple optical problem: objectives or filters are dirty. Clean them accordingly. You can also check that all the components are well in place and aligned.
- Your light sheet might not be properly aligned. For Lightsheet Z.1, please realign the light sheet using the Light sheet auto-adjust function of the ZEN software.
- You could be imaging through an additional layer of material: glass, plastic... that belong to the mounting support and not the sample itself. Please, check the sample position or move it around to see if another angle solve the problem as a piece of glue, additional agarose or part of the mounting material is having a blurring effect.
- In the case of sample embedding it may occur that the gelling media is of low quality or badly polymerized. This leads to an uneven polymerization of the media that modify the optical path. Try again.
- The light sheet comes from the side and any obstacle modifies its quality. Check the illumination axis for any obstacle (capillary, objects...).
- Check if the medium level in the sample chamber has dropped below the imaging level. The specimen has to be fully immersed for good image quality.

Sample image is partially obscured or unevenly illuminated.

- This can be a simple optical problem: objectives or filters are dirty. Clean them accordingly. You can also check that all the components are well in place and aligned.
- Your light sheet might not be properly aligned. For Lightsheet Z.1, please realign the light sheet using the Light sheet auto-adjust function of the ZEN software.

- The light sheet comes from the side and any obstacle modifies its quality. Check the illumination axis for any obstacle (capillary, objects...).

Sample signal is weak.

- Human eyes have trouble quickly adjusting to the dark and it will be hard to discern a very dim fluorescent specimen immediately after darkening the room. You may want to check your sample using another microscope or a stereomicroscope equipped with a fluorescent lamp.
- It could be an optical problem, e.g. extra filter in the optical path, misaligned illumination or dying laser. You can also increase excitation energy (laser). However, the risk of bleaching and signal saturation will increase.
- In the case of immunofluorescence, you should increase antibody concentration or incubation time but this might in turn increase nonspecific background signal.
- In the case of GFP signal, the expression level might be too low or you have photobleached or damaged the GFP signal during sample preparation (fixation, ethanol treatment, excessive illumination during dissection...).

High background signal within the sample.

- In the case of immunofluorescence, you should decrease antibody concentration or incubation time
- but this may decrease the overall signal. You can also use blocking steps during the immunofluorescence (eg. BSA, FCS...). If preparing tissue section, you should increase the stringency of the washing steps.
- The imaging chamber may be dirty as well as the media inside. This contamination affects the quality of the light sheet and scattering occurs.
- You can apply deconvolution to your stacks afterwards.

The sample is moving.

- If you are imaging live samples, it may be simply due to life. The sample is moving so you may want to increase the anesthetic concentration or the agarose concentration to restrain any movement.
- The mounting is unstable. This occurs if the chosen material is not properly maintained (bad tweezers, leaking plunger, badly polymerized agarose...). For embedded sample preparation, you can improve the stability by limiting the amount of agarose emerging out of the syringe or the capillary, as the longer is the agarose

tube the more unstable it will be. You can also tighten the plunger by sealing it with nail polish to avoid air leakage that will lead to gliding of the agarose tube.

- The system table might not be a float. Check that it is connected to the pneumatic supply and the air-dampening is active.
- The cables are not properly secured with the cable holders at the system table.
- Other instruments that produce vibrations, not completely dampened by the system table, are in close proximity (e.g. fridges, centrifuges, etc.).
- The stage is not properly fitted or damaged and prone to vibrations. This includes the sample holder and the imaging chamber support.

Optical aberrations

- As in any optical technique, the LSFM has advantages and disadvantages. Some optical aberrations are more general and can be dealt with easily. Do not hesitate to ask experts in the field, check the literature as well as Internet resources that may provide a more detailed solution to the problem you have encountered.
- A few optical aberrations are, however, typical for LSFM, as the optical axis are at a 90 degrees angles. Lines and stripes occur as any objects blocking the light sheet will reduce the light intensity leading to a discrepancy along the illuminated plane. This is often a problem with big samples, highly scattering samples or sample which have absorbing structures at the surface of the specimen volume. Rotating the sample to give a better path for the light sheet should be considered first. Dual Side illumination and/or Pivot scanning of the light sheet can often eliminate these effects (available in Lightsheet Z.1) Second, the sample could be orientated differently during mounting or partially dissected to limit obstacles. The concentration of the objects can also be a problem especially with samples with optical properties (beads, tubes, glass capillaries...). For example, if you image large number of cell clusters, you may have a few of them in the light sheet path. By reducing the amount of objects, you will automatically reduce the lines and stripes.
- The use of image processing methods such as deconvolution may help to get rid of those aberrations.

4.3 Suggested Additional Sources of Information

Chemicals

- Agarose:
 - Molecular biology grade, for routine use, SIGMA, Ref. A-9539
 - Type VII, low gelling temperature, SIGMA, Ref. A-4018-50G
 - “Agarose Low Melt” (no 6351.1) from Carl Roth www.carlroth.com (from the US please contact Brunschwig Chemie B.V., Amsterdam, NL, e-Mail: brunschwig@brunschwig.nl)
- Gelrite Gellan Gum, SIGMA, Ref. G-1910
- Glycerine anhydrous, AppliChem, Ref. A3552,1000
- Nail Polish, any cosmetic shop near you
- PBS, local supplier
- Distilled water, local supplier
- Ethanol, local supplier
- Companies:
 - Sigma- Aldrich (<http://www.sigmaaldrich.com/>)
 - AppliChem (<http://www.applichem.de/>)
 - MP Biomedicals (<http://www.mpbio.com/>)
 - Merck KGa (<http://www.merck.de/>)

Materials

- Capillaries
 - 100 µl, color code Blue, Brand GmbH, Ref. 7087 45
 - 200 µl, color code Red, Brand GmbH, Ref. 7087 57
- Companies:
 - Brand GmbH (<http://www.brand.de/en/home/>)
 - SpectraGlass (<http://www.spectraglass.com/>)
 - Harvard Apparatus (<http://www.harvardapparatus.com/>)
- Syringes
 - 1 ml, BD Plastipak, BD Biosciences, Ref.300013
 - 0.5 ml, BD Microfine Insulin U100 Syringe, 29 g, Ref. PLA257L
 - 0.3 ml, BD Microfine Insulin U100 Syringe, 30 g, Ref. PLA470U
 - Braun Omnifix F Solo 1 ml Syringe (PZN 0569881, Ref. 61706)
 - Terumo 1 ml Syringe (Ref. BS-01T)

Pipettes

- 2 ml serological pipette, FALCON, BD Labware, Ref.35 7507
- 1 ml serological pipette, FALCON, BD Labware, Ref.35 7521

Equipment

For the following, please refer to your local lab supply companies:

- Heating blocks
- Stereomicroscope
- Scalpels
- Tweezers
- Dissection Needles
- Watch glass
- Sonicator

4.4 References and Further Reading

- Buytaert, J.A.N. et al., 2011. The OPFOS Microscopy Family: High-Resolution Optical Sectioning of Biomedical Specimens. *Anatomy research international*, 2012.
- Capoulade, J. et al., 2011. Quantitative fluorescence imaging of protein diffusion and interaction in living cells. *Nature biotechnology*, 29(9), pp.835–839.
- Dodt, H.U. et al., 2007. Ultramicroscopy: three-dimensional visualization of neuronal networks in the whole mouse brain. *Nature methods*, 4(4), pp.331–336.
- Ejsmont, R.K. et al., 2009. A toolkit for high-throughput, cross-species gene engineering in *Drosophila*. *Nature methods*.
- Engelbrecht, C.J. et al., 2007. Three-dimensional laser microsurgery in light-sheet based microscopy (SPIM). *Optics Express*, 15(10), pp.6420–6430.
- Engelbrecht, C.J., Voigt, F. & Helmchen, F., 2010. Miniaturized selective plane illumination microscopy for high-contrast in vivo fluorescence imaging. *Optics letters*, 35(9), pp.1413–1415.
- Fahrbach, F.O. & Rohrbach, A., 2010. A line scanned light-sheet microscope with phase shaped selfreconstructing beams. *Optics Express*, 18(23), pp.24229–24244.
- Fuchs, E. et al., 2002. Thin laser light sheet microscope for microbial oceanography. *Optics Express*, 10(2), p.145.
- Hama H, Kurokawa H, Kawano H, Ando R, Shimogori T, Noda H, Fukami K, Sakaue-Sawano A, Miyawaki A. 2011. Scale: a chemical approach for fluorescence imaging and reconstruction of transparent mouse brain. *Nat Neurosci*. 14(11):1481-8.
- Hofman, R. et al., 2008. Morphology and function of Bast’s valve: additional insight in its functioning using D-reconstruction. *European Archives of Oto-Rhino-Laryngology*, 265(2), pp.153–157.
- Hofman, R., Segenhout, J. & Wit, H., 2009. Three-dimensional reconstruction of the guinea pig inner ear, comparison of OPFOS and light microscopy, applications of 3D reconstruction. *Journal of microscopy*, 233(2), pp.251–257.
- Holekamp, T.F., Turaga, D. & Holy, T.E., 2008. Fast three-dimensional fluorescence imaging of activity in neural populations by objective-coupled planar illumination microscopy. *Neuron*, 57(5), pp.661–672.
- Huber, D., Keller, M. & Robert, D., 2001. 3D light scanning macrography. *Journal of microscopy*, 203(2), pp.208–213.
- Huisken, J. et al., 2004. Optical sectioning deep inside live embryos by selective plane illumination microscopy. *Science*, 305(5686), pp.1007–1009.
- Jährling, N. et al., 2010. Three-dimensional reconstruction and segmentation of intact *Drosophila* by ultramicroscopy. *Frontiers in systems neuroscience*, 4.

- Kalinka, A.T. et al., 2010. Gene expression divergence recapitulates the developmental hourglass model. *Nature*, 468(7325), pp.811–814.
- Karaköylü, E.M. et al., 2009. Copepod feeding quantified by planar laser imaging of gut fluorescence. *Limnology and Oceanography: Methods*, 7, pp.33–41.
- Kaufmann, A. et al., 2012. Multilayer mounting enables long-term imaging of zebrafish development in a light sheet microscope. *Development*, 139(17), pp.3242–3247.
- Keller, P.J. et al., 2008. Three-Dimensional Microtubule Behavior in *Xenopus* Egg Extracts Reveals Four Dynamic States and State-Dependent Elastic Properties. *Biophysical journal*, 95(3), pp.1474–1486.
- Lorenzo, C. et al., 2011. Live cell division dynamics monitoring in 3D large spheroid tumor models using light sheet microscopy. *Cell Division*, 6(1), p.22.
- Maizel, A. et al., 2011. High-resolution live imaging of plant growth in near physiological bright conditions using light sheet fluorescence microscopy. *The Plant Journal*, 68(2), pp.377–385.
- Mertz, J. & Kim, J., 2010. Scanning light-sheet microscopy in the whole mouse brain with HiLo background rejection. *Journal of biomedical optics*, 15(1).
- Olarte, O.E. et al., 2012. Image formation by linear and nonlinear digital scanned light-sheet fluorescence microscopy with Gaussian and Bessel beam profiles. *Biomedical Optics Express*, 3(7), pp.1492–1505.
- Pampaloni, F., Reynaud, E.G. & Stelzer, E.H.K., 2007. The third dimension bridges the gap between cell culture and live tissue. *Nature reviews Molecular cell biology*, 8(10), pp.839–845.
- Ritter, J.G. et al., 2008. High-contrast single-particle tracking by selective focal plane illumination microscopy. *Optics express*, 16(10), pp.7142–7152.
- Rubio-Guivernau, J.L. et al., 2012. Wavelet-based image fusion in multi-view three-dimensional microscopy. *Bioinformatics*, 28(2), pp.238–245.
- Santi, P.A. et al., 2009. Thin-sheet laser imaging microscopy for optical sectioning of thick tissues. *Biotechniques*, 46(4), p.287.
- Scherz, P.J. et al., 2008. High-speed imaging of developing heart valves reveals interplay of morphogenesis and function. *Development*, 135(6), pp.1179–1187.
- Schröter, T.J. et al., 2012. Scanning thin-sheet laser imaging microscopy (sTSLIM) with structured illumination and HiLo background rejection. *Biomedical Optics Express*, 3(1), pp.170–177.

5 Index

A

Antifading Agents..... 21

F

FEP Tubing..... 15

Fixation and Fixatives..... 20

L

LSFM

Sample Mounting..... 22

M

Materials and Equipment

Sample Chambers..... 15

Molding and Mounting Supports..... 16

Sample Holder..... 18

Gels and Polymers..... 18

Hydrogel Preparation..... 19

S

Sample

Holding..... 6

Sample Preparation

Preparation of Fluorescent Beads..... 22

Preparation of a Medaka Fish Embryo..... 23

Preparation of a Fly Pupa..... 24

Preparation of a Plant Root..... 24

Samples

Embedded..... 8

Hanging..... 12

Enclosed..... 13

Cleaning, Labelling, and Storing..... 21

Stains and Staining..... 20



Carl Zeiss Microscopy GmbH
07745 Jena, Germany
BioSciences
microscopy@zeiss.com
www.zeiss.com/microscopy



We make it visible.